

XXVII ALPE ADRIA GRAND PRIX JUN/SEN

2022.10.01 - 2022.10.01

Via delle Scienze 100, 33100, Udine ITA

ITALY,ITA



U36 F -48 KG

XXVII ALPE ADRIA GRAND PRIX JUN/SEN, Via delle Scienze 100, 33100, Udine ITA, ITA

Tatami

Pool
1/1

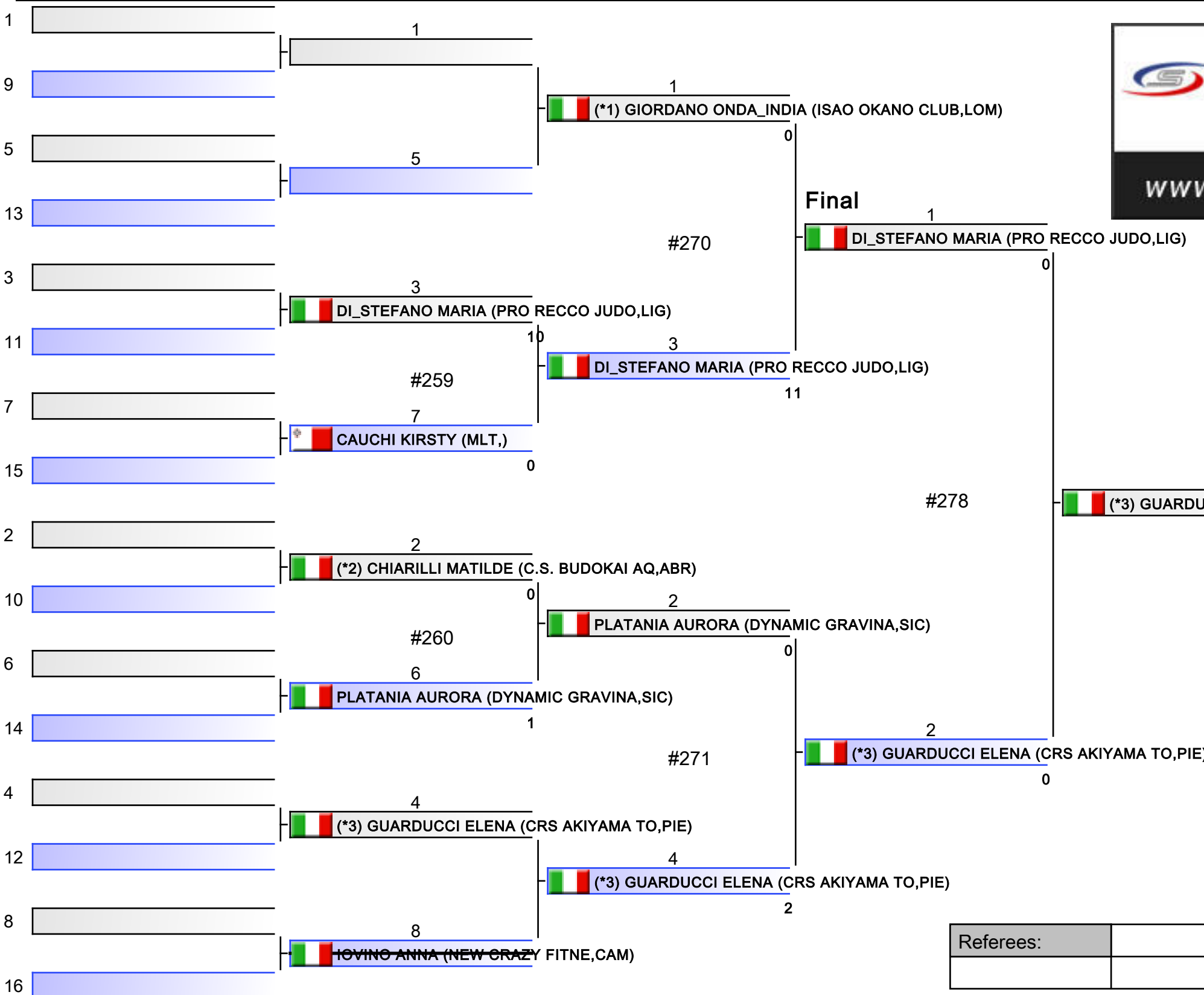

1. GUARDUCCI ELENA (CRS AKIYAMA TO)
2. DI_STEFANO MARIA (PRO RECCO JUDO)
3. PLATANIA AURORA (DYNAMIC GRAVINA)
3. GIORDANO ONDA_INDIA (ISAO OKANO CLUB)
5. CAUCHI KIRSTY (MLT)
5. CHIARILLI MATILDE (C.S. BUDOKAI AQ)

*Seeded

Referees:			

U36 F -48 KG

XXVII ALPE ADRIA GRAND PRIX JUN/SEN

Tatami

Pool

1

(c)sportdata GmbH & Co KG 2000-2022 (2022-10-01 18:46) v 9.9.0 build 1 (2022-09-21) License: Online_Event_ID-628_XXVIIALPEADRIAGRANDPRIXJUNSEN (expire 2022-10-15)

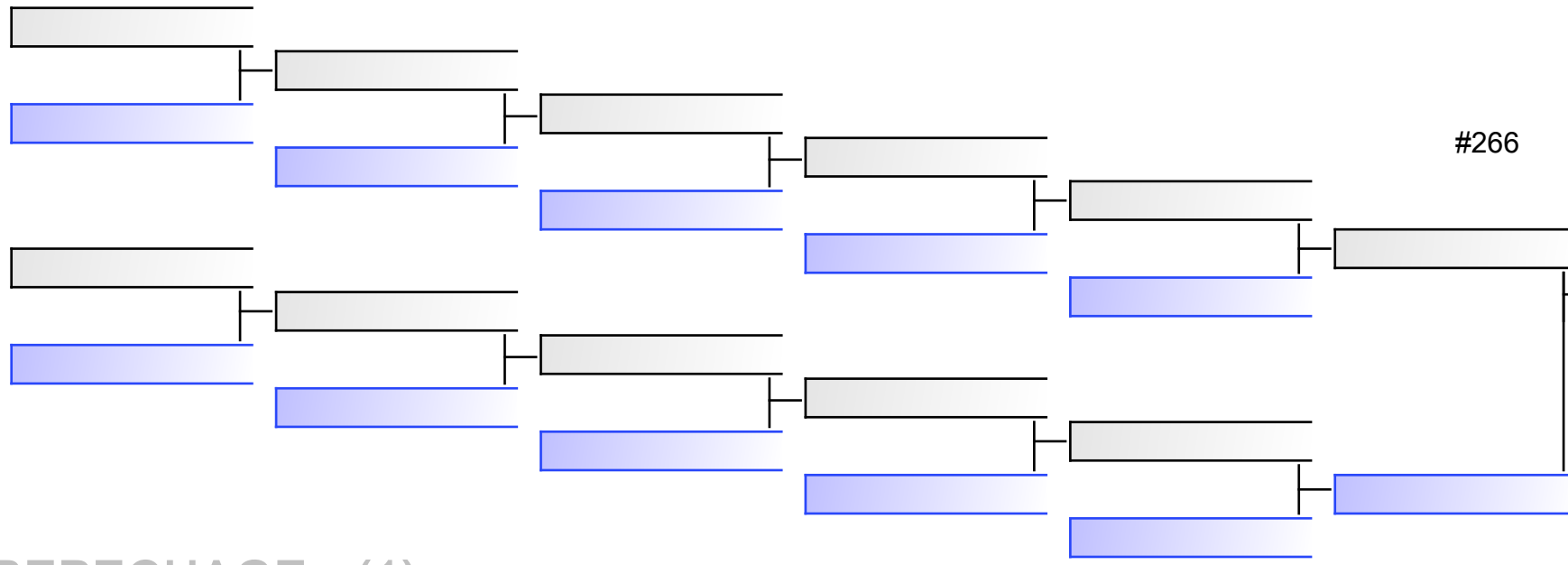

#266

CAUCHI KIRSTY (MLT) 0
PLATANIA AURORA (DYNAMIC GRAVINA) 0

REPECHAGE: (1)

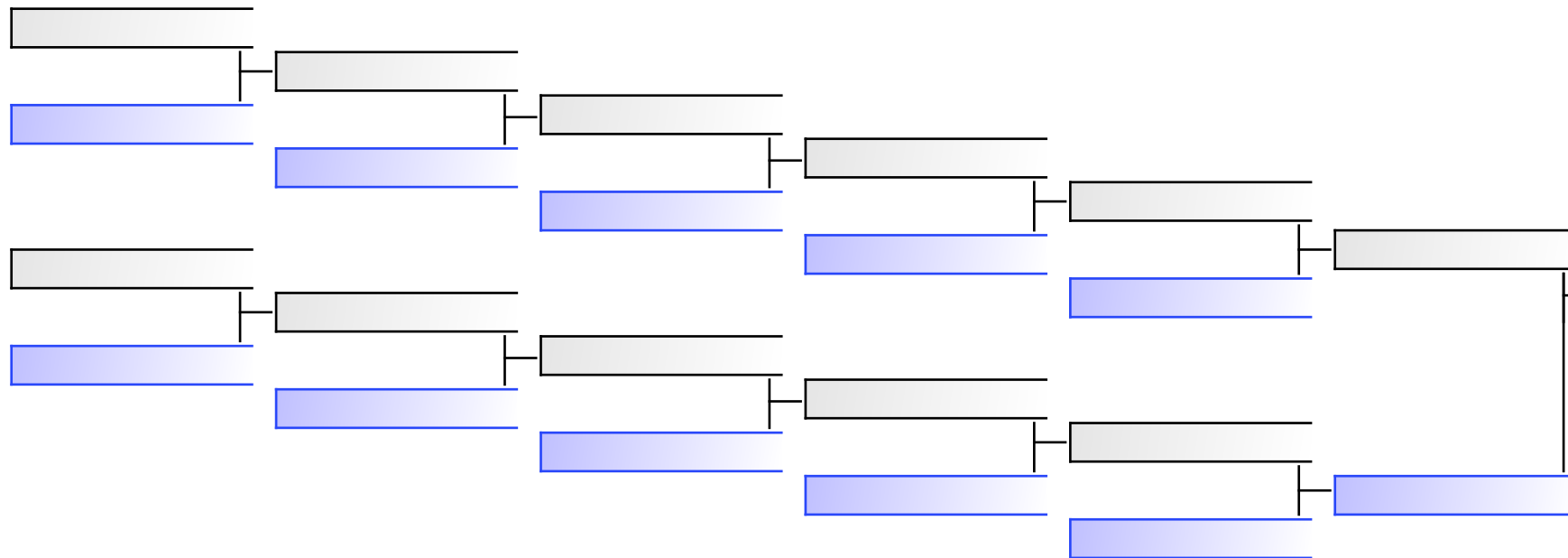

#275

CHIARILLI MATILDE (C.S. BUDOKAI AQ) 0
GIORDANO ONDA_INDIA (ISAO OKANO CLUB) 2

Referees:							
-----------	--	--	--	--	--	--	--

U36 F -52 KG

XXVII ALPE ADRIA GRAND PRIX JUN/SEN, Via delle Scienze 100, 33100, Udine ITA, ITA

Tatami

Pool
1/1

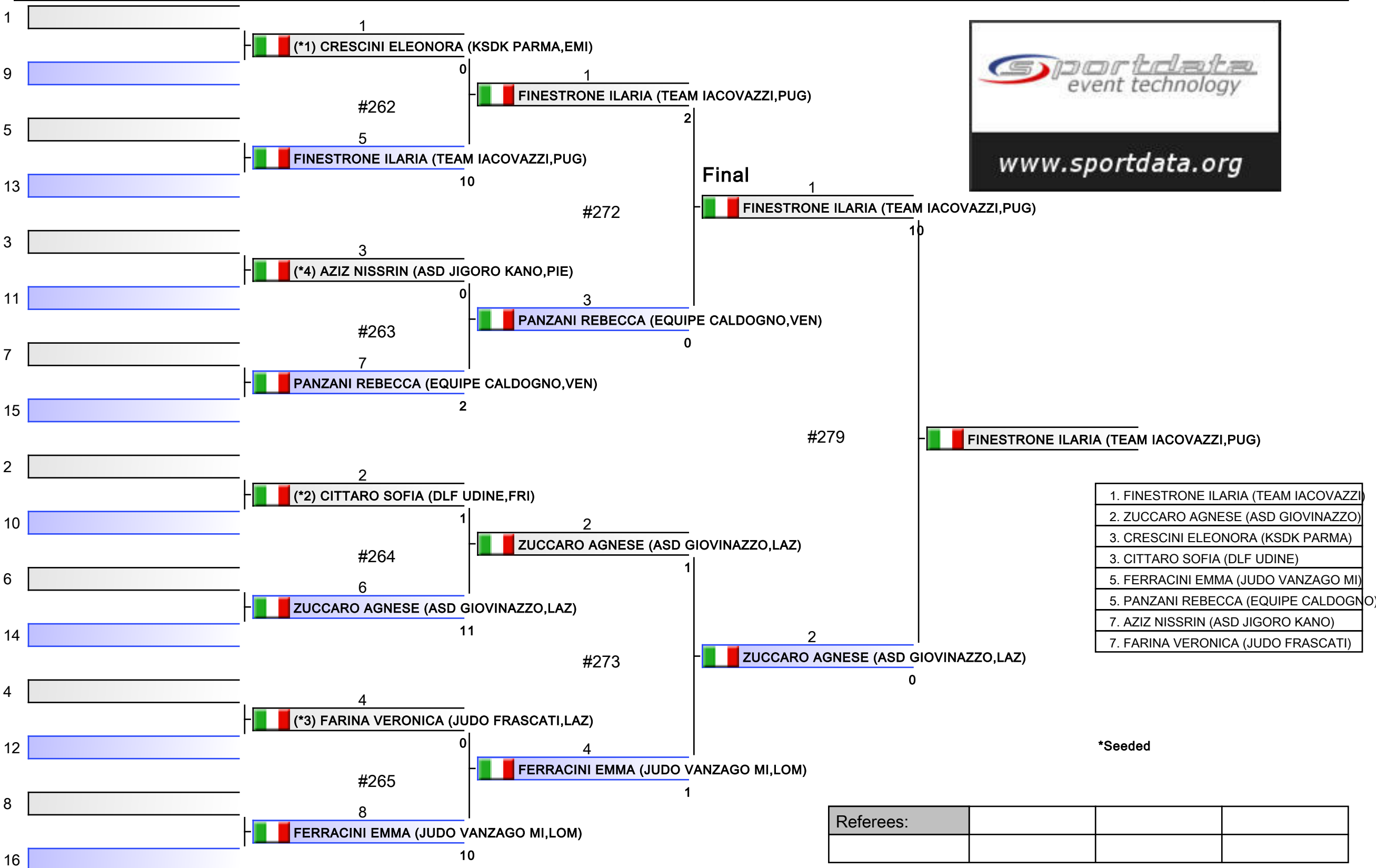

U36 F -52 KG

XXVII ALPE ADRIA GRAND PRIX JUN/SEN

Tatami

Pool
1

(c)sportdata GmbH & Co KG 2000-2022 (2022-10-01 18:46) v 9.9.0 build 1 (2022-09-21) License: Online_Event_ID-628_XXVIIALPEADRIAGRANDPRIXJUNSEN (expire 2022-10-15)

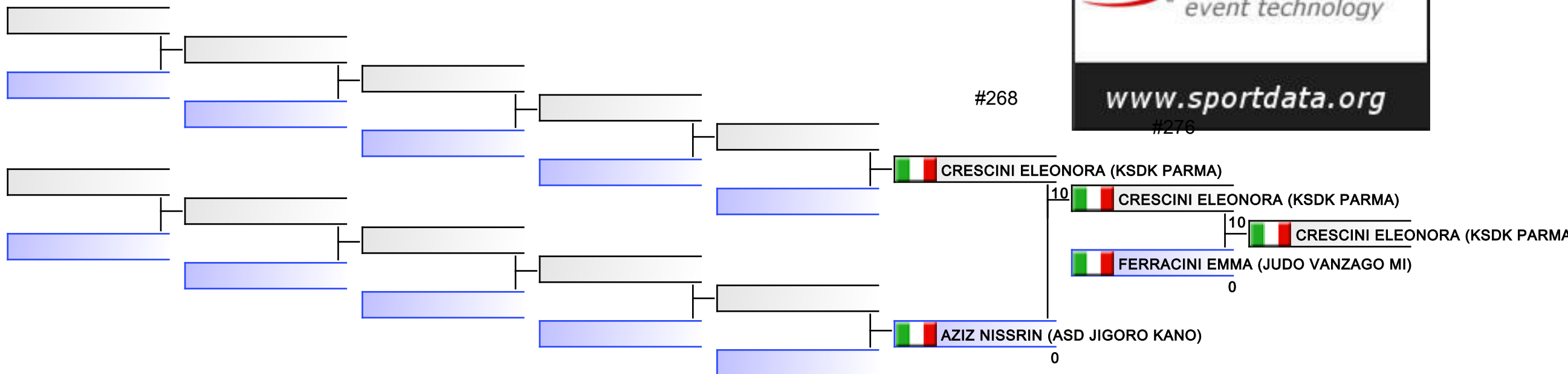

REPECHAGE: (1)

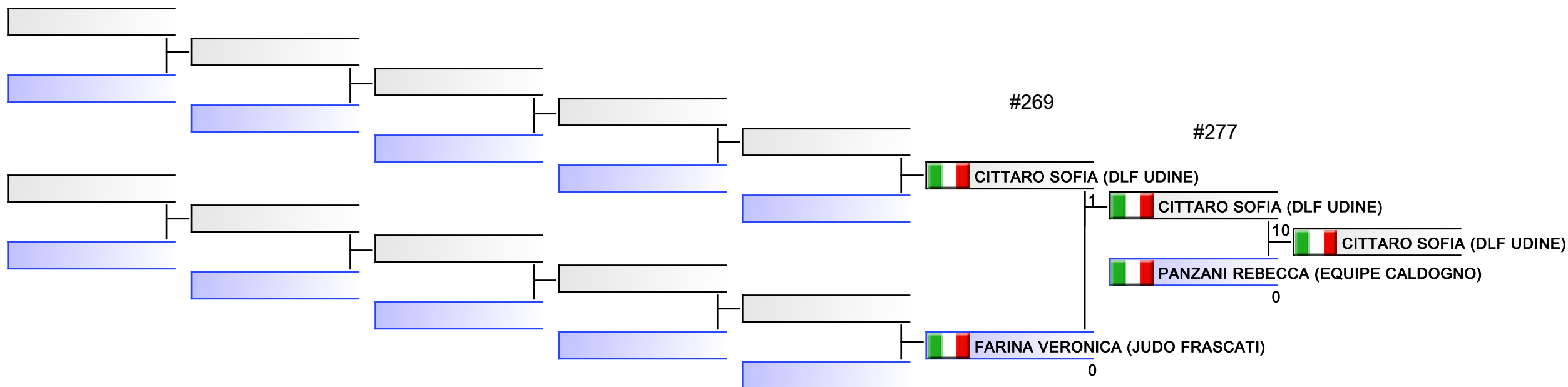

Referees:							
-----------	--	--	--	--	--	--	--

U36 F -57 KG

XXVII ALPE ADRIA GRAND PRIX JUN/SEN, Via delle Scienze 100, 33100, Udine ITA, ITA

Tatami

Pool
1/1

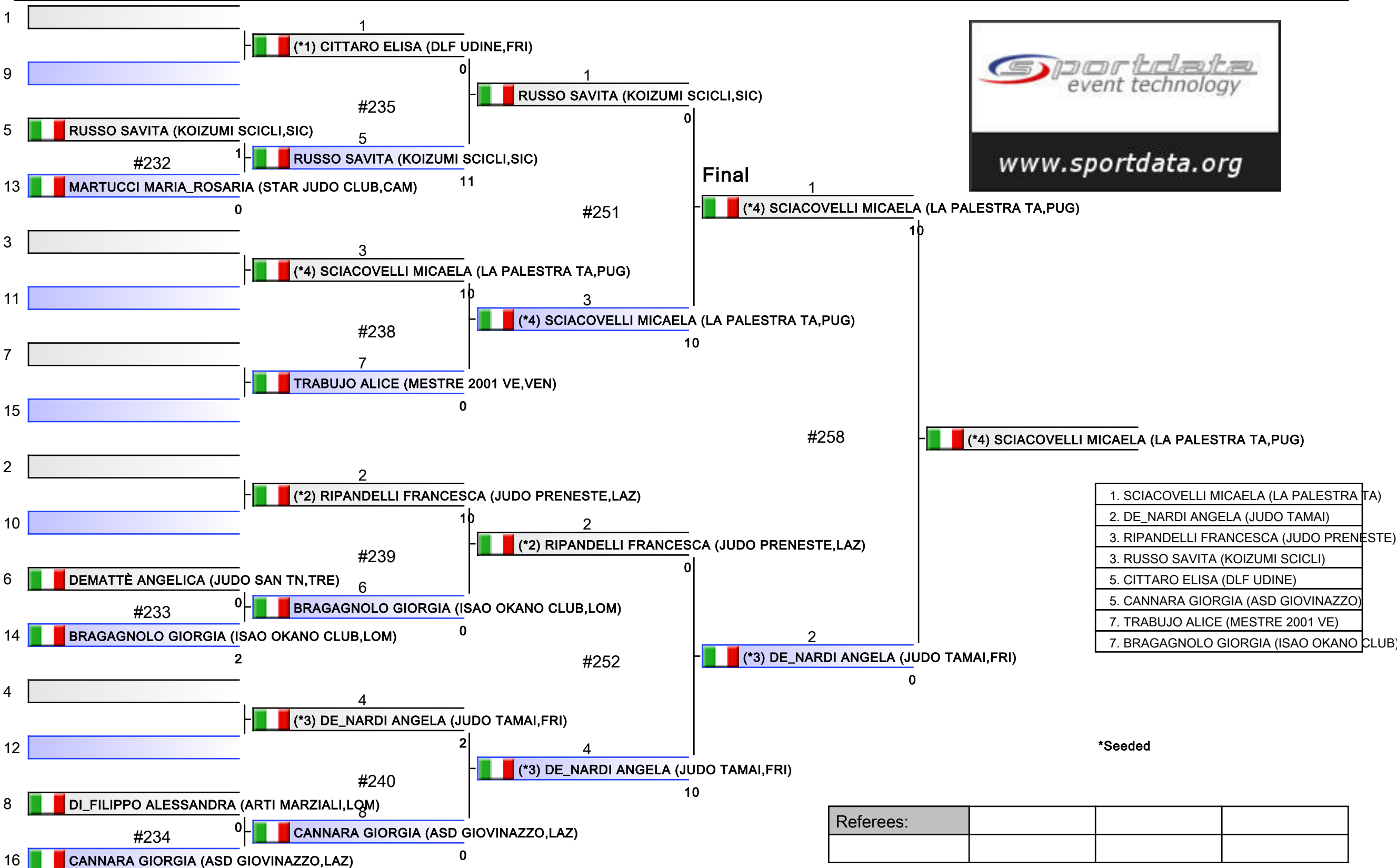

U36 F -57 KG

XXVII ALPE ADRIA GRAND PRIX JUN/SEN

(c)sportdata GmbH & Co KG 2000-2022 (2022-10-01 18:46) v 9.9.0 build 1 (2022-09-21) License: Online_Event_ID-628_XXVIIALPEADRIAGRANDPRIXJUNSEN (expire 2022-10-15)

Tatami

Pool
1

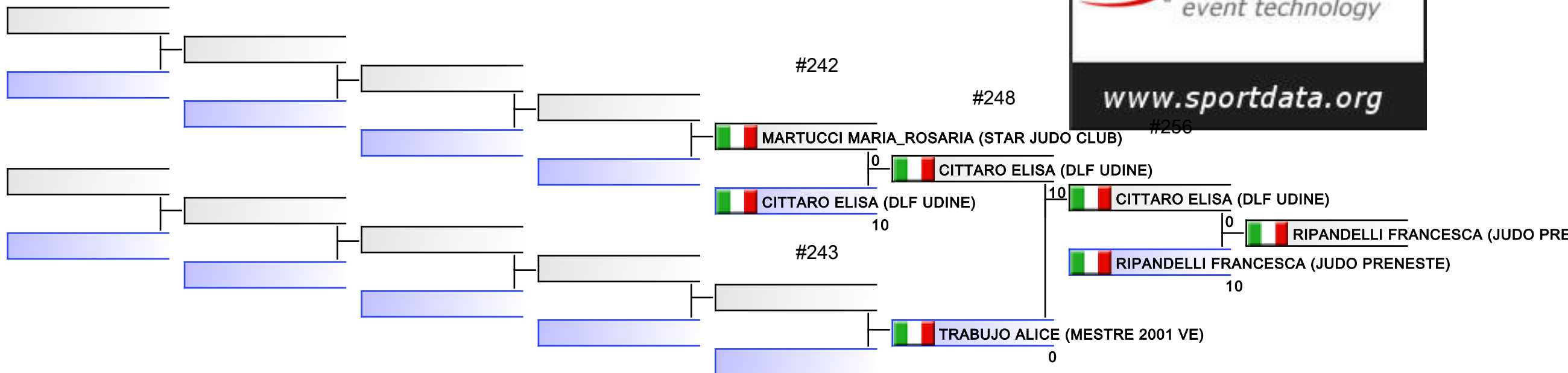

REPECHAGE: (1)

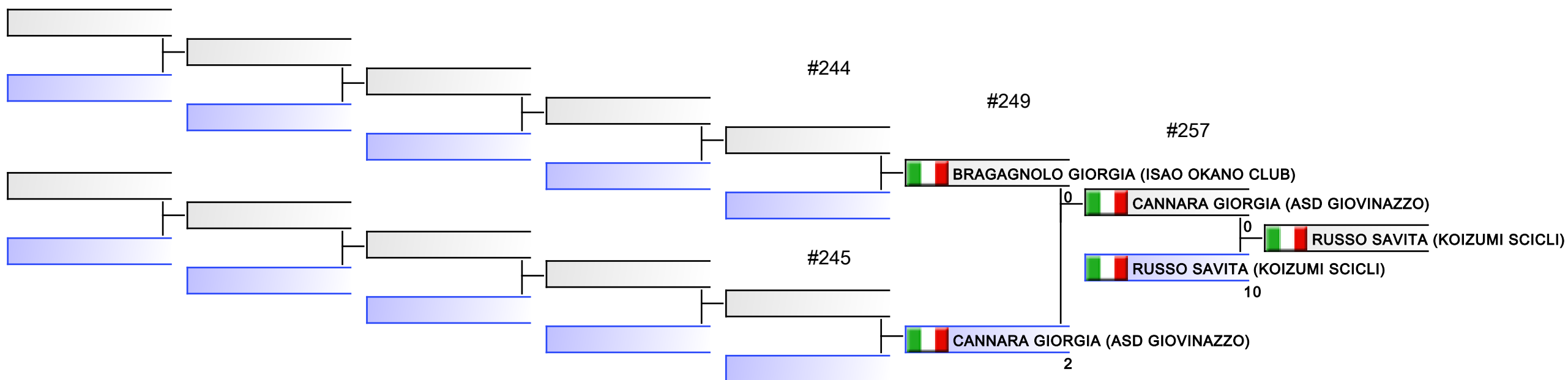

Referees:							
-----------	--	--	--	--	--	--	--

U36 F -63 KG

XXVII ALPE ADRIA GRAND PRIX JUN/SEN, Via delle Scienze 100, 33100, Udine ITA, ITA

Tatami

Pool
1/1

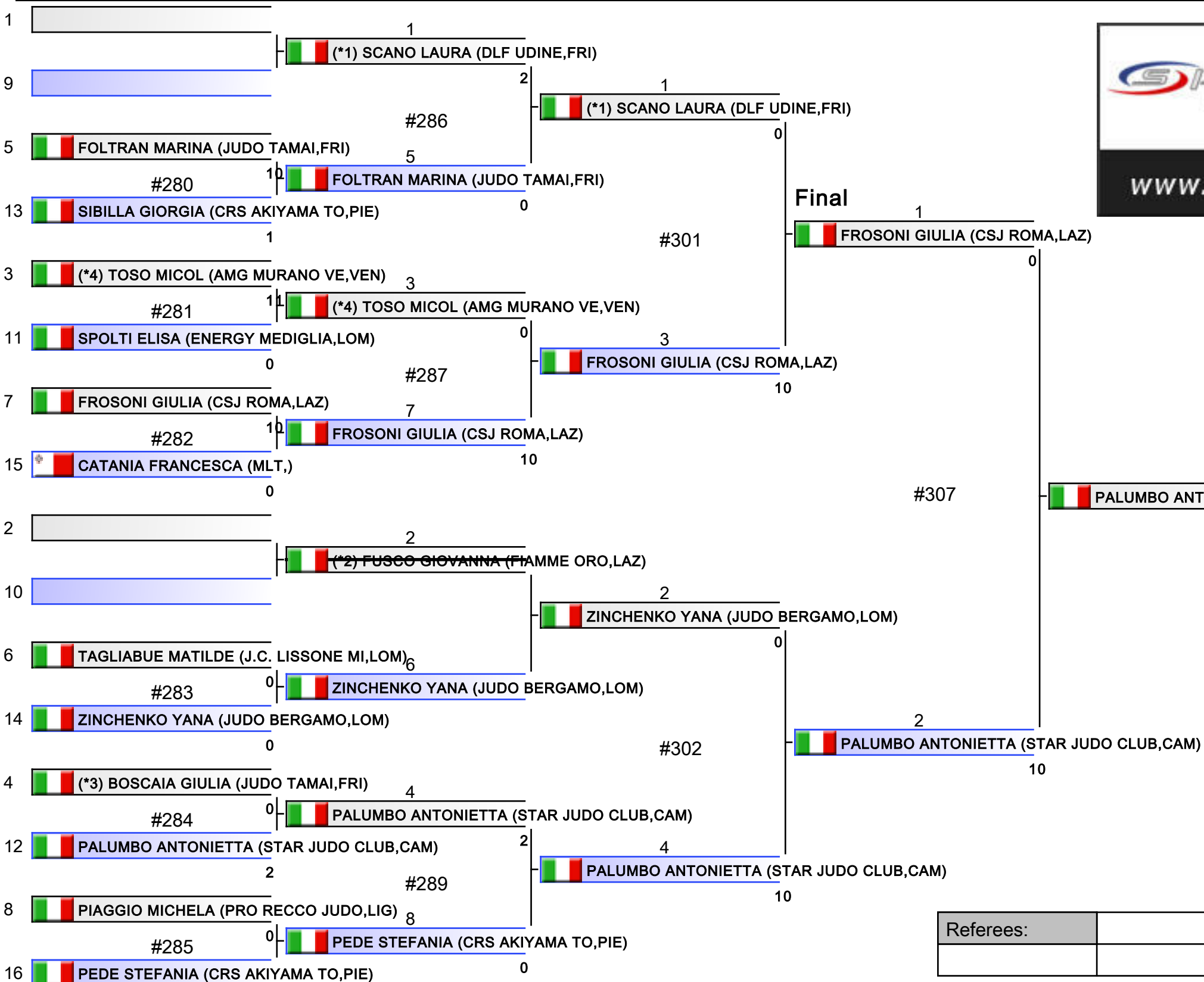

- | |
|--|
| 1. PALUMBO ANTONIETTA (STAR JUDO CLUB) |
| 2. FROSONI GIULIA (CSJ ROMA) |
| 3. ZINCHENKO YANA (JUDO BERGAMO) |
| 3. SCANO LAURA (DLF UDINE) |
| 5. FOLTRAN MARINA (JUDO TAMAI) |
| 5. TAGLIABUE MATILDE (J.C. LISSONE MI) |
| 7. TOSO MICOL (AMG MURANO VE) |
| 7. PEDE STEFANIA (CRS AKIYAMA TO) |

*Seeded

Referees:			

U36 F -63 KG

XXVII ALPE ADRIA GRAND PRIX JUN/SEN

(c)sportdata GmbH & Co KG 2000-2022 (2022-10-01 18:46) v 9.9.0 build 1 (2022-09-21) License: Online_Event_ID-628_XXVIIALPEADRIAGRANDPRIXJUNSEN (expire 2022-10-15)

Tatami

Pool
1

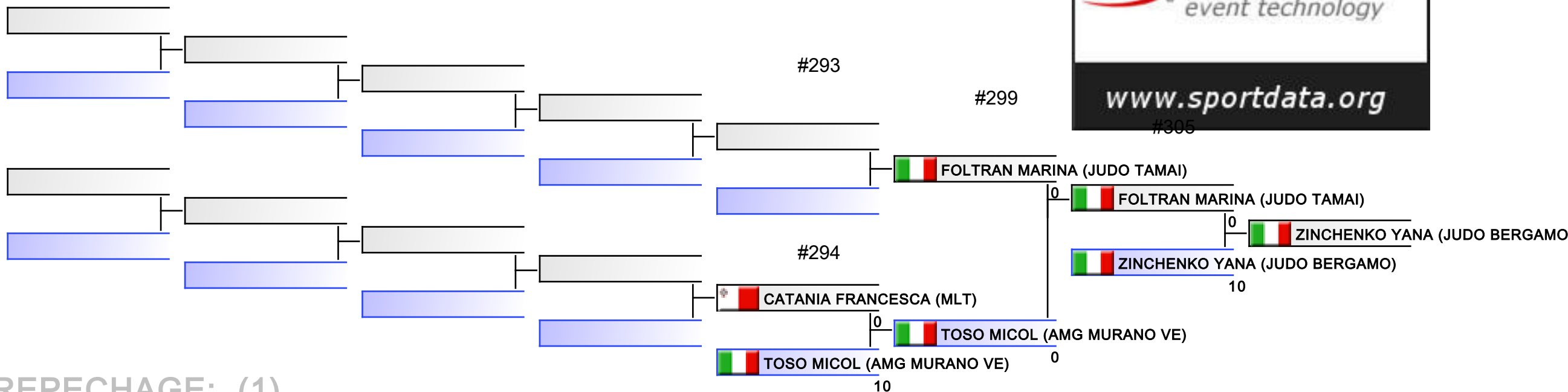

REPECHAGE: (1)

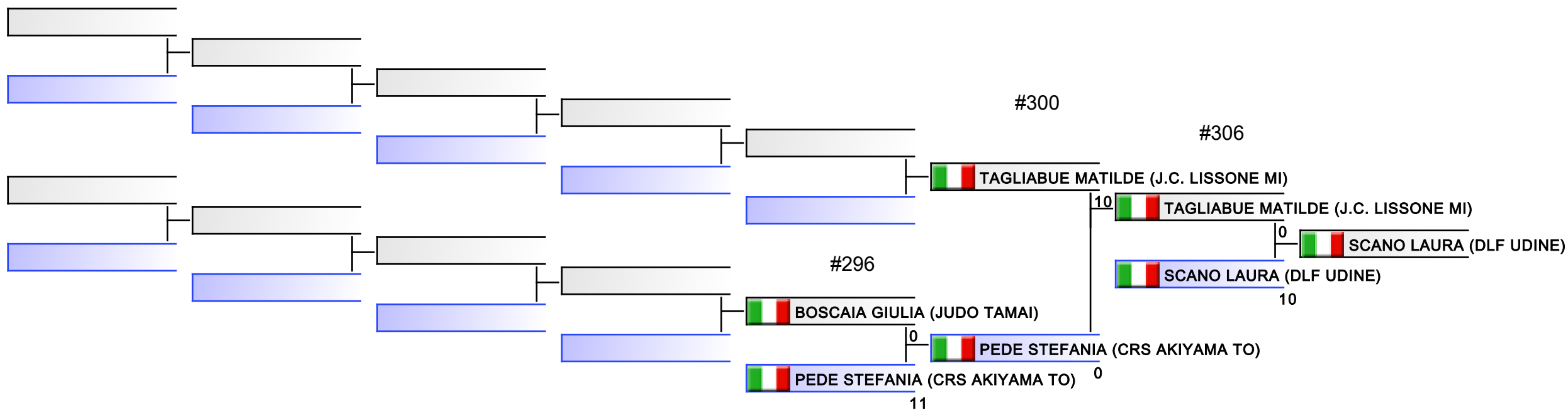

Referees:							
-----------	--	--	--	--	--	--	--

U36 F -70 KG

XXVII ALPE ADRIA GRAND PRIX JUN/SEN, Via delle Scienze 100, 33100, Udine ITA, ITA

Tatami

Pool
1/1

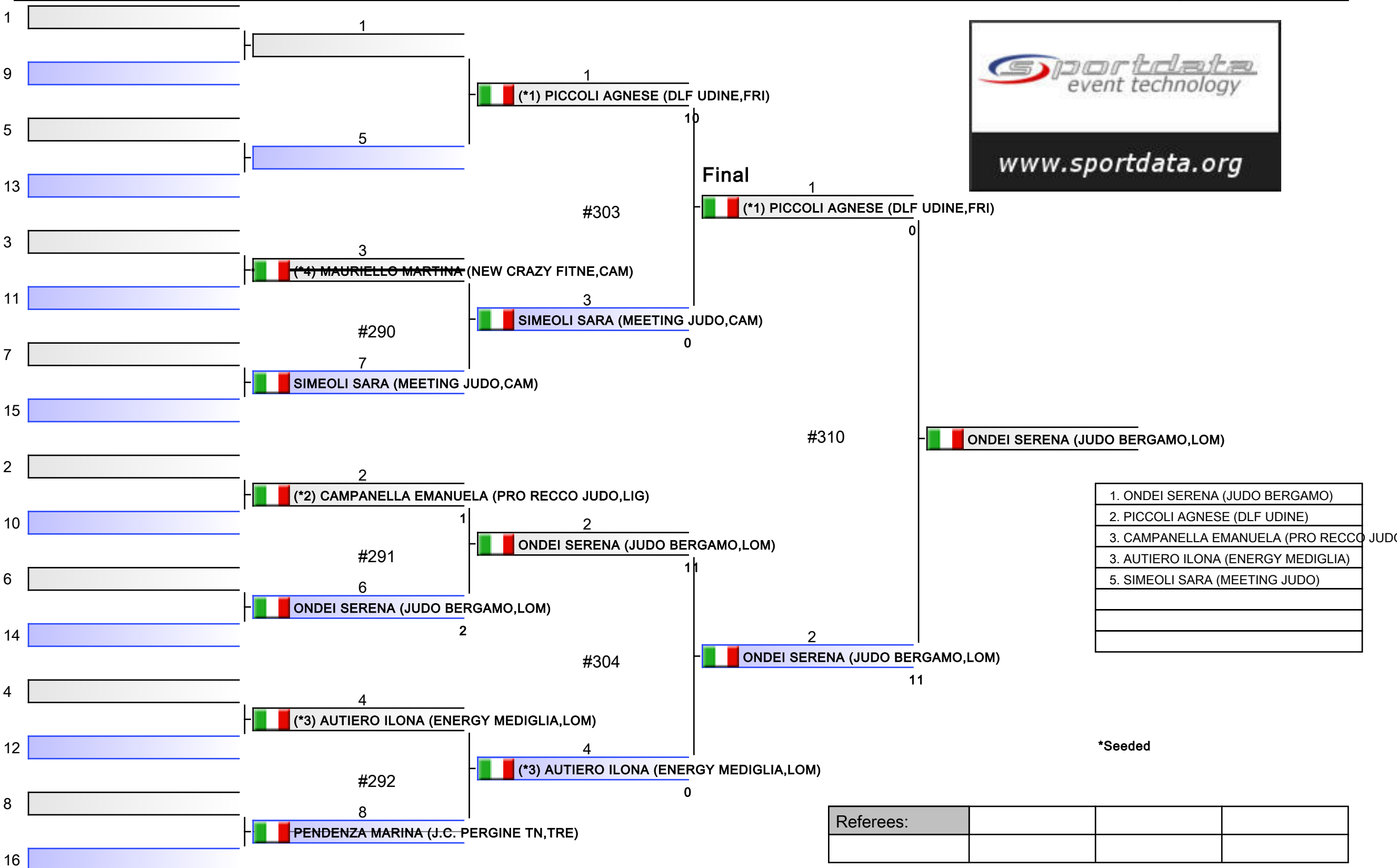

1. ONDEI SERENA (JUDO BERGAMO)
2. PICCOLI AGNESE (DLF UDINE)
3. CAMPANELLA EMANUELA (PRO RECCO JUDO)
3. AUTIERO ILONA (ENERGY MEDIGLIA)
5. SIMEOLI SARA (MEETING JUDO)

*Seeded

Referees:			

U36 F -70 KG

XXVII ALPE ADRIA GRAND PRIX JUN/SEN

(c)sportdata GmbH & Co KG 2000-2022 (2022-10-01 18:46) v 9.9.0 build 1 (2022-09-21) License: Online_Event_ID-628_XXVIIALPEADRIAGRANDPRIXJUNSEN (expire 2022-10-15)

Tatami

Pool
1

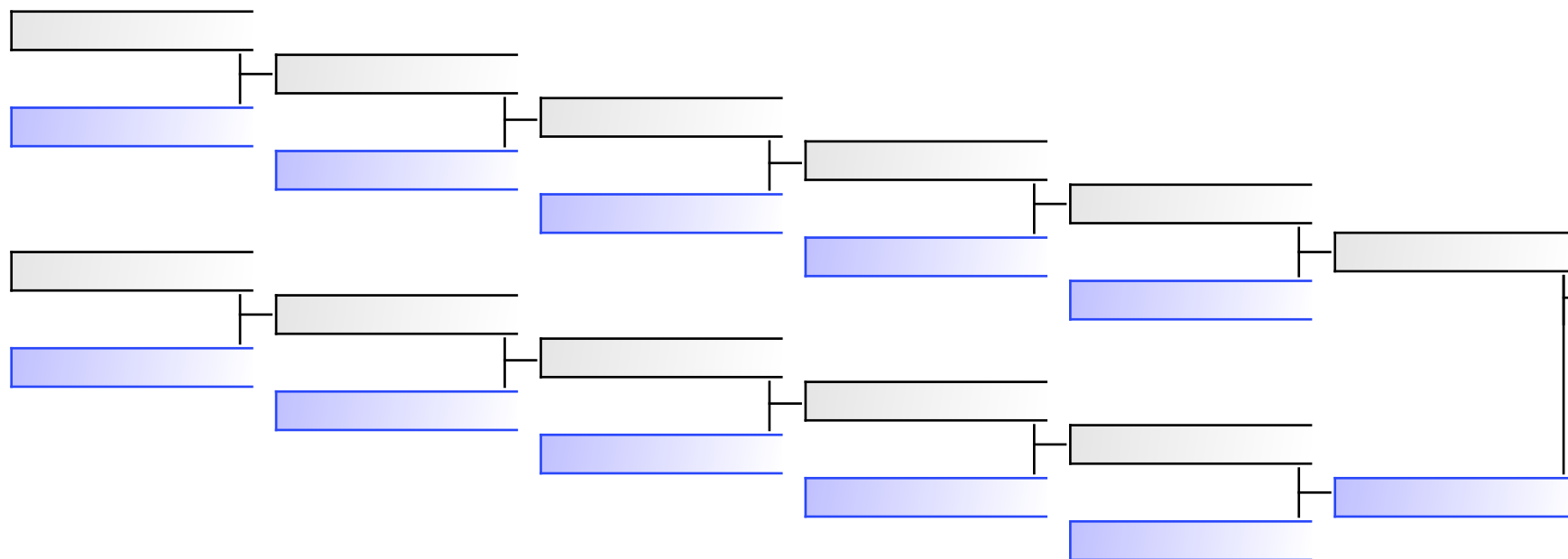

 AUTIERO ILONA (ENERGY MEDIGLIA)
 AUTIERO ILONA (ENERGY MEDIGLIA)

REPECHAGE: (1)

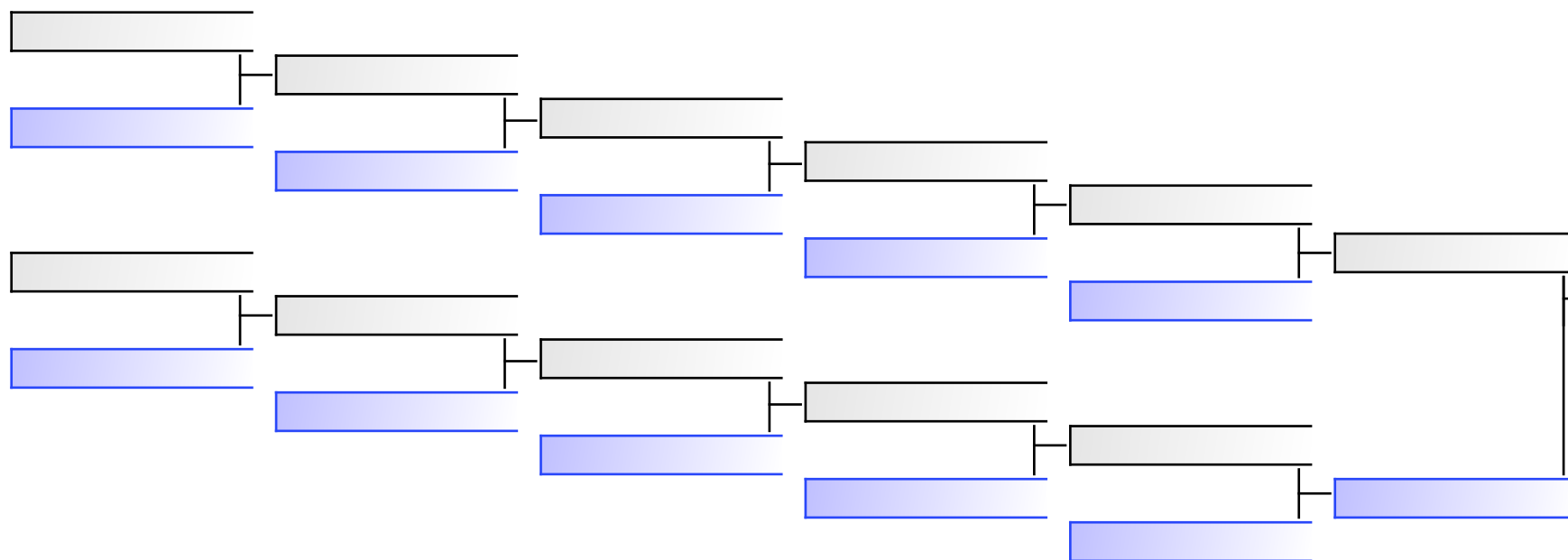

#309

 CAMPANELLA EMANUELA (PRO RECCO JUDO)
10
 CAMPANELLA EMANUELA (PRO RECCO JUDO)
0
 SIMEOLI SARA (MEETING JUDO)

Referees:							
-----------	--	--	--	--	--	--	--

U36 F -78 KG

XXVII ALPE ADRIA GRAND PRIX JUN/SEN, Via delle Scienze 100, 33100, Udine ITA, ITA

Tatami

Pool
1/1

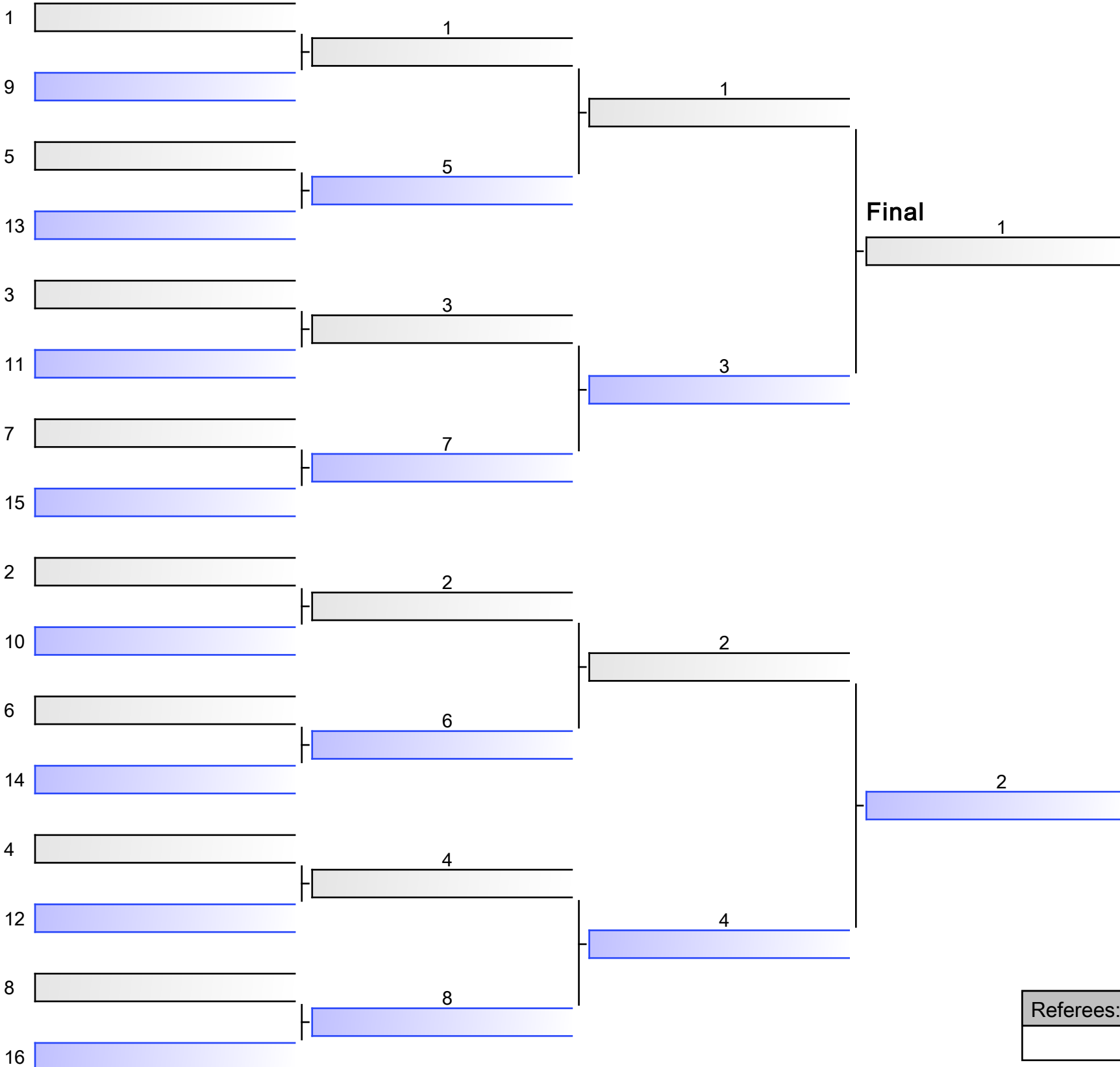

 SALVADORI MARISOL (JUDO TREVISO, VEN)

[Original]

Referees:			

U36 F +78 KG

XXVII ALPE ADRIA GRAND PRIX JUN/SEN, Via delle Scienze 100, 33100, Udine ITA, ITA

Tatami

Pool
1/1

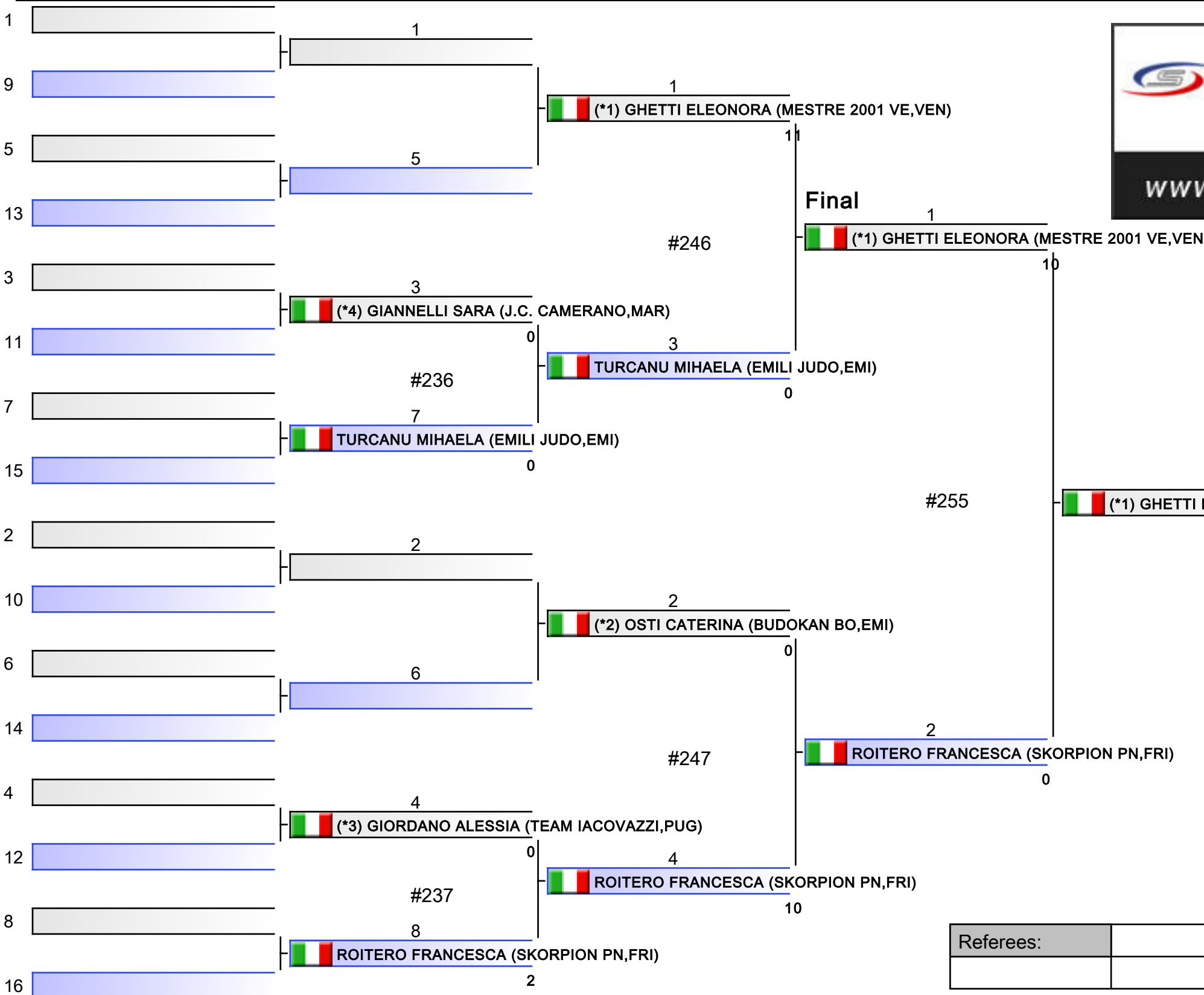

1. GHETTI ELEONORA (MESTRE 2001 VE)
2. ROITERO FRANCESCA (SKORPION PN)
3. GIANNELLI SARA (J.C. CAMERANO)
3. GIORDANO ALESSIA (TEAM IACOVAZZI)
5. OSTI CATERINA (BUDOKAN BO)
5. TURCANU MIHAELA (EMILI JUDO)

*Seeded

Referees:			

U36 F +78 KG

XXVII ALPE ADRIA GRAND PRIX JUN/SEN

Tatami

Pool

1

(c)sportdata GmbH & Co KG 2000-2022 (2022-10-01 18:46) v 9.9.0 build 1 (2022-09-21) License: Online_Event_ID-628_XXVIIALPEADRIAGRANDPRIXJUNSEN (expire 2022-10-15)

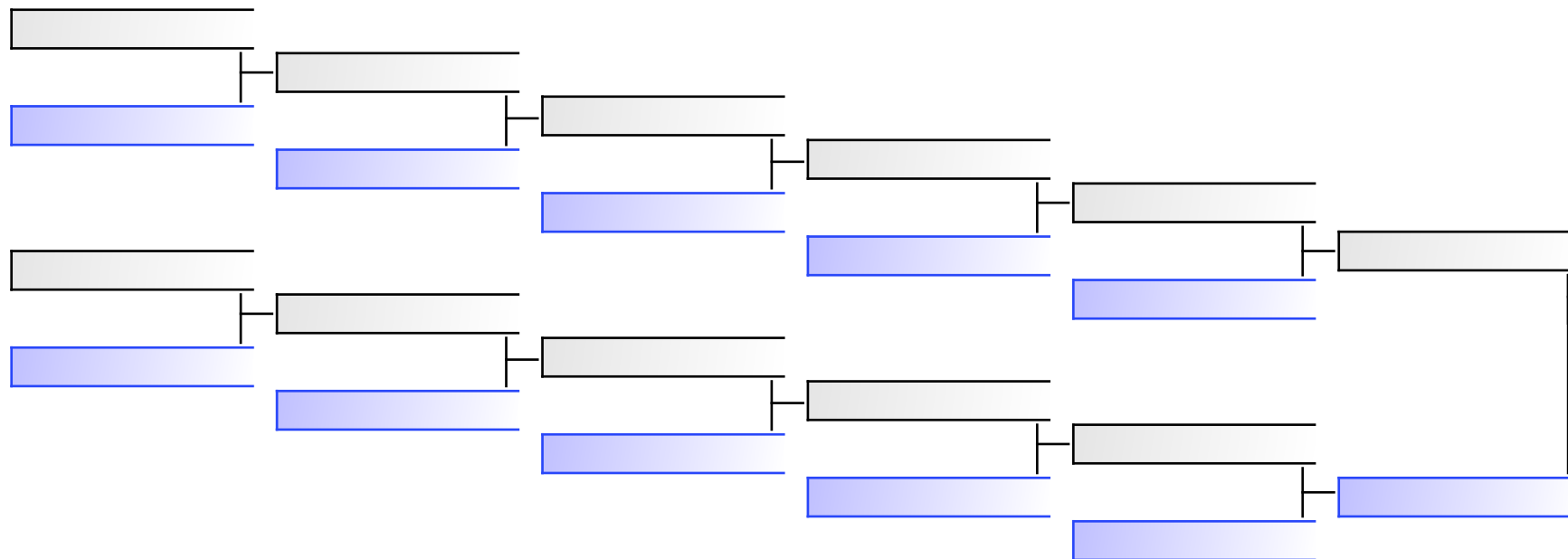

#253

GIANNELLI SARA (J.C. CAMERANO)
 1 GIANNELLI SARA (J.C. CAMERANO)
 OSTI CATERINA (BUDOKAN BO)
 0

REPECHAGE: (1)

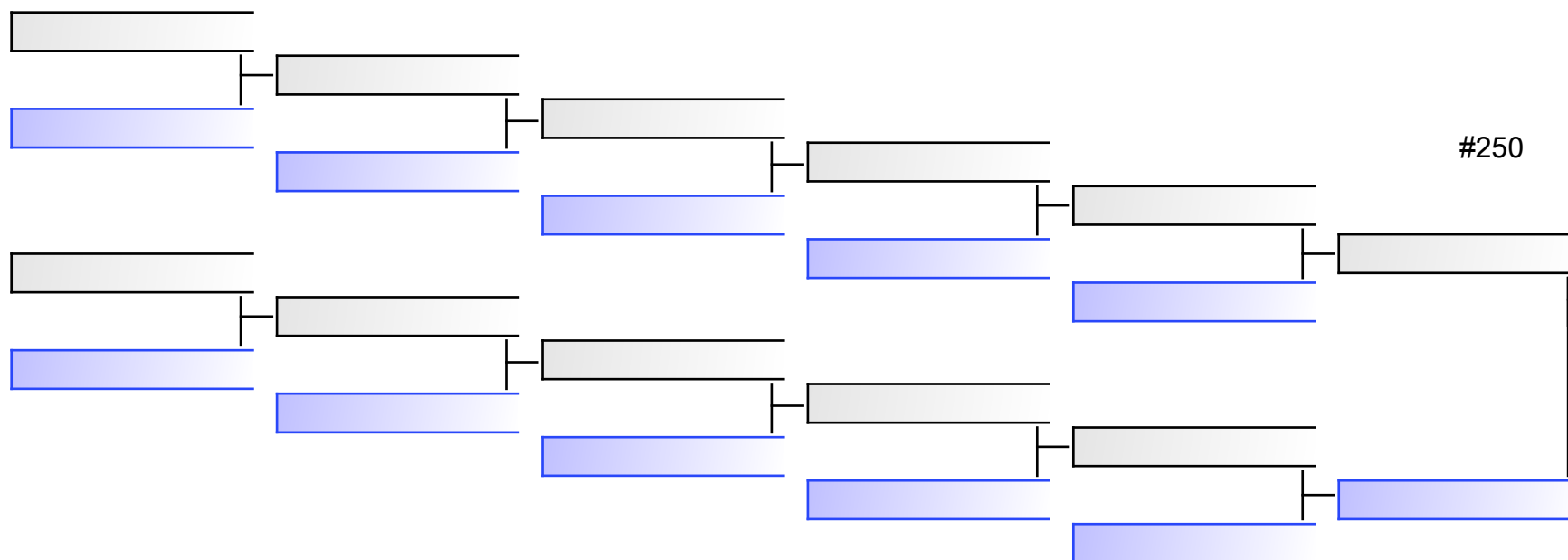

#250

#254

GIORDANO ALESSIA (TEAM IACOVAZZI)
 2 GIORDANO ALESSIA (TEAM IACOVAZZI)
 TURCANU MIHAELA (EMILI JUDO)
 0

Referees:							
-----------	--	--	--	--	--	--	--

U36 M -60 KG

XXVII ALPE ADRIA GRAND PRIX JUN/SEN, Via delle Scienze 100, 33100, Udine ITA, ITA

Tatami

Pool
1/1

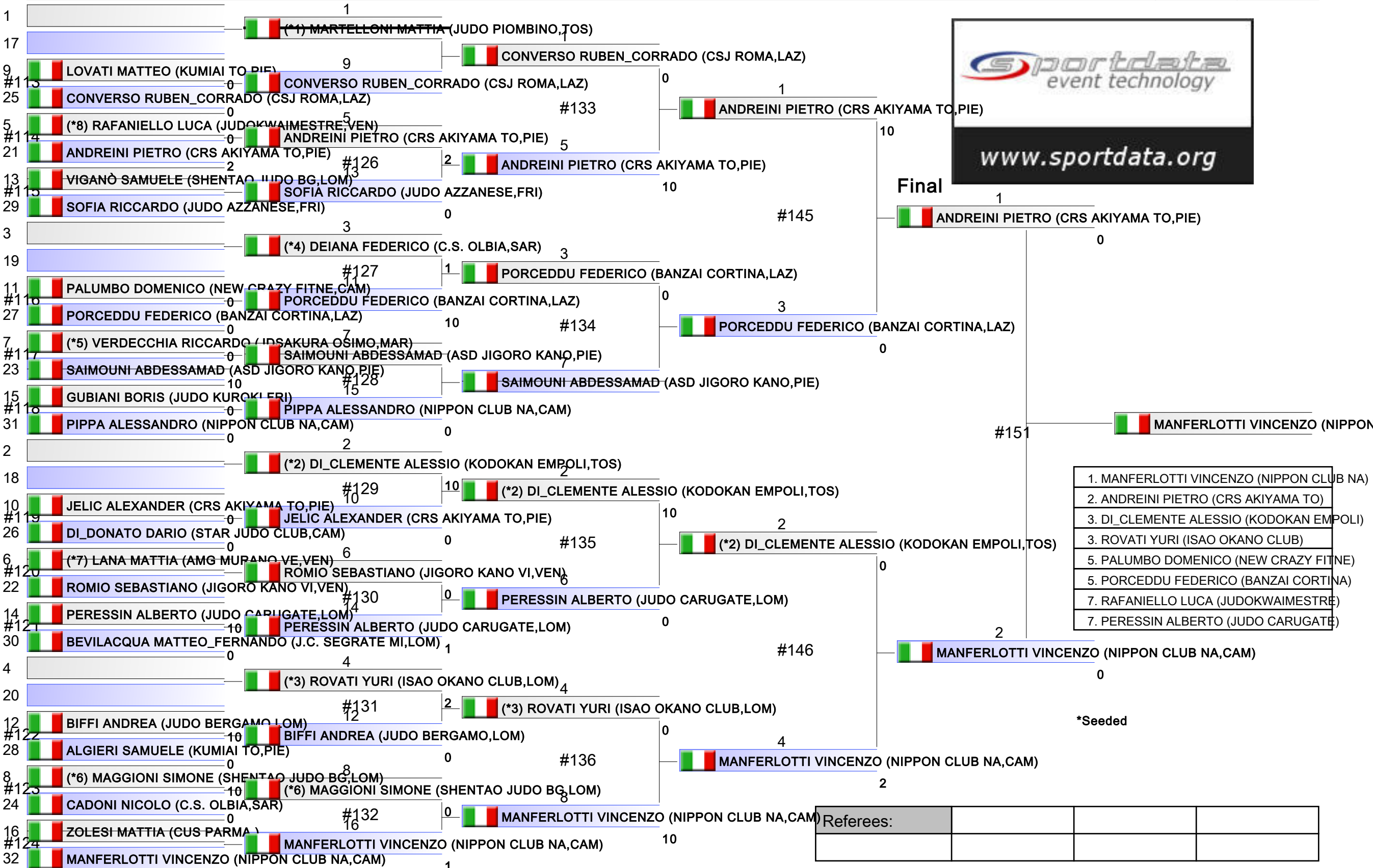

U36 M -60 KG

XXVII ALPE ADRIA GRAND PRIX JUN/SEN

(c)sportdata GmbH & Co KG 2000-2022 (2022-10-01 18:46) v 9.9.0 build 1 (2022-09-21) License: Online_Event_ID-628_XXVIIALPEADRIAGRANDPRIXJUNSEN (expire 2022-10-15)

Tatami

Pool
1

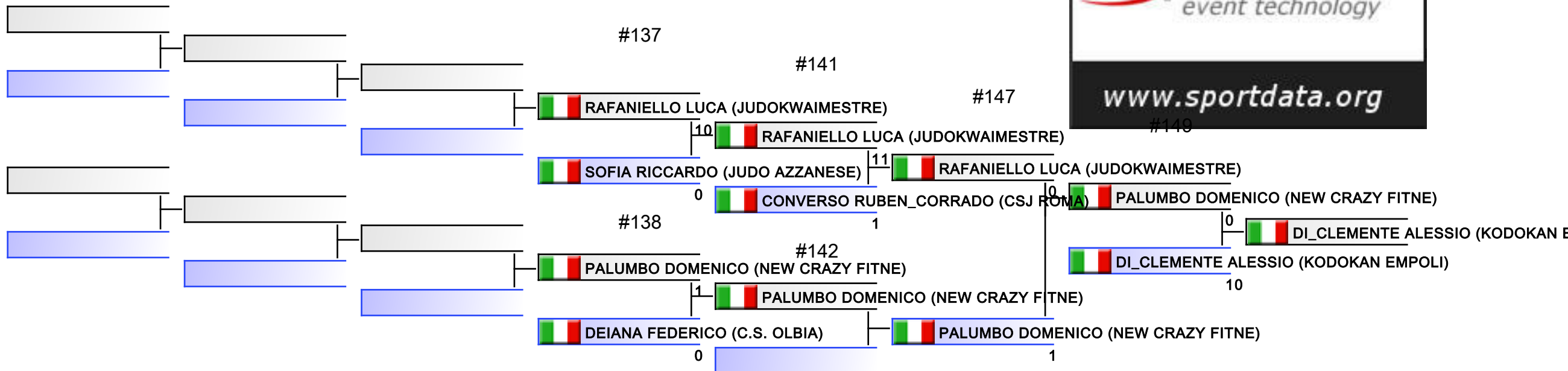

REPECHAGE: (1)

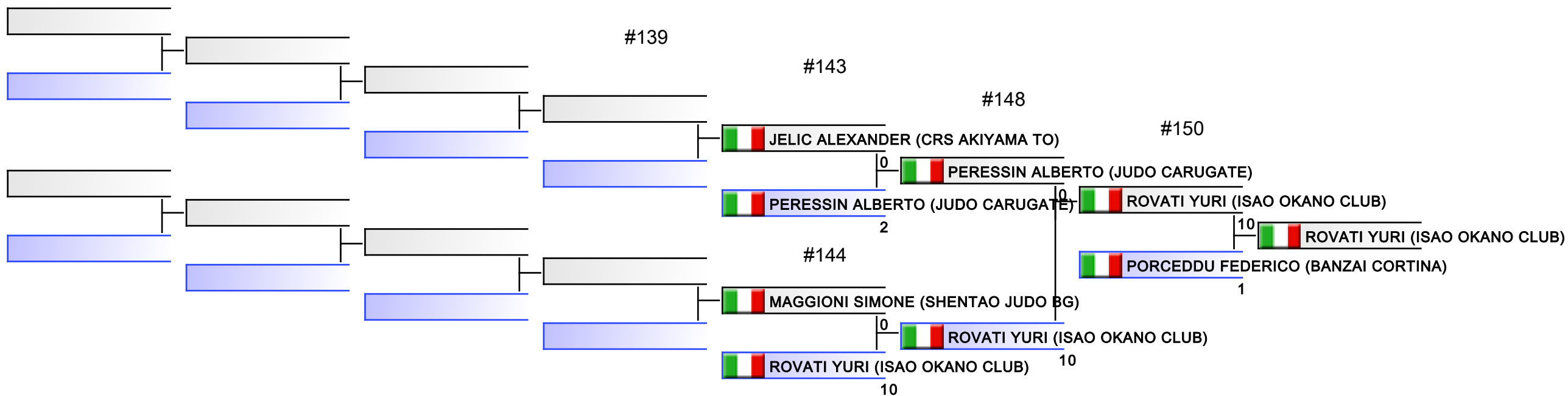

Referees:							
-----------	--	--	--	--	--	--	--

U36 M -66 KG

XXVII ALPE ADRIA GRAND PRIX JUN/SEN, Via delle Scienze 100, 33100, Udine ITA, ITA

Tatami

Pool
1/2

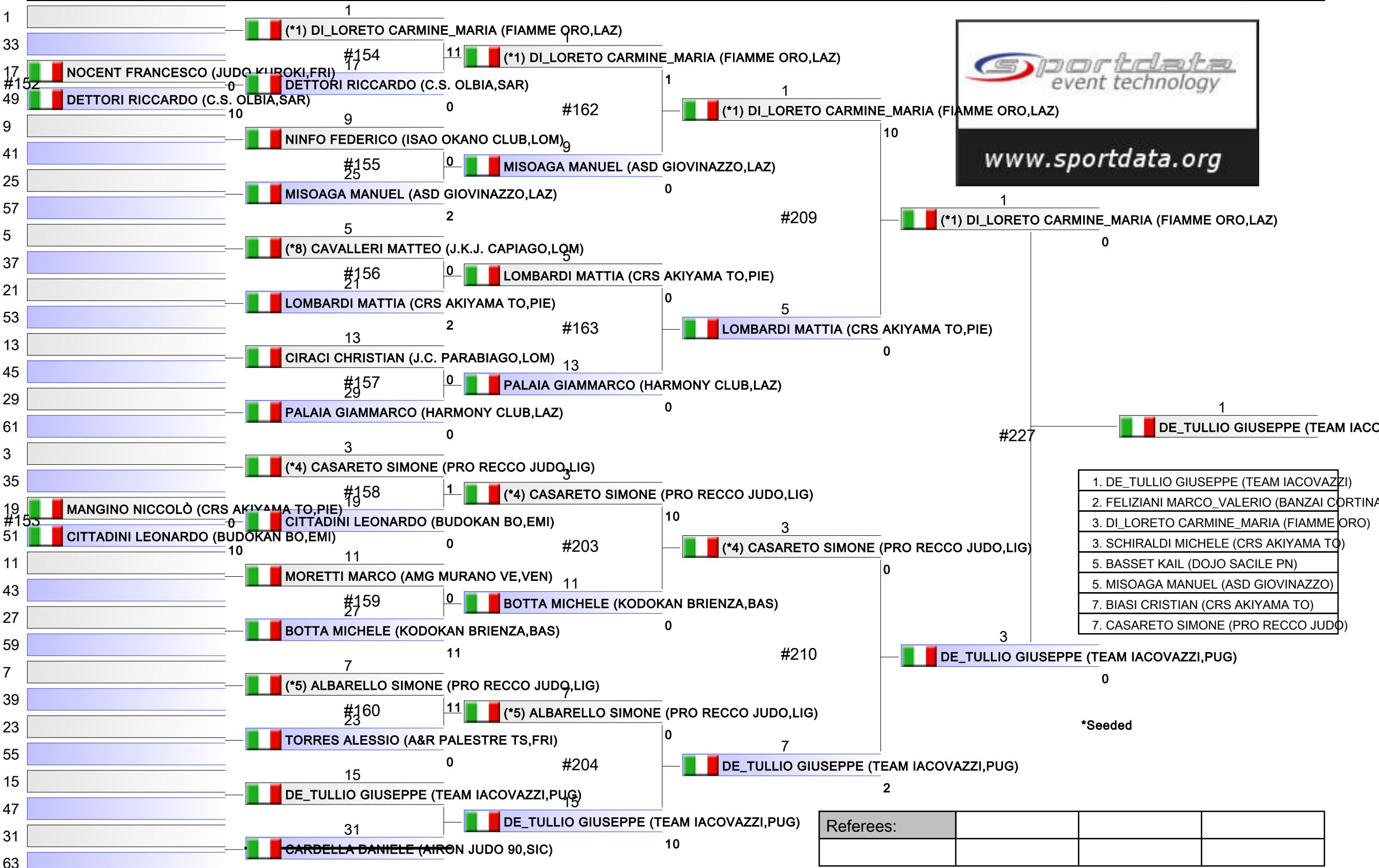

U36 M -66 KG

XXVII ALPE ADRIA GRAND PRIX JUN/SEN, Via delle Scienze 100, 33100, Udine ITA, ITA

Tatami

Pool
2/2

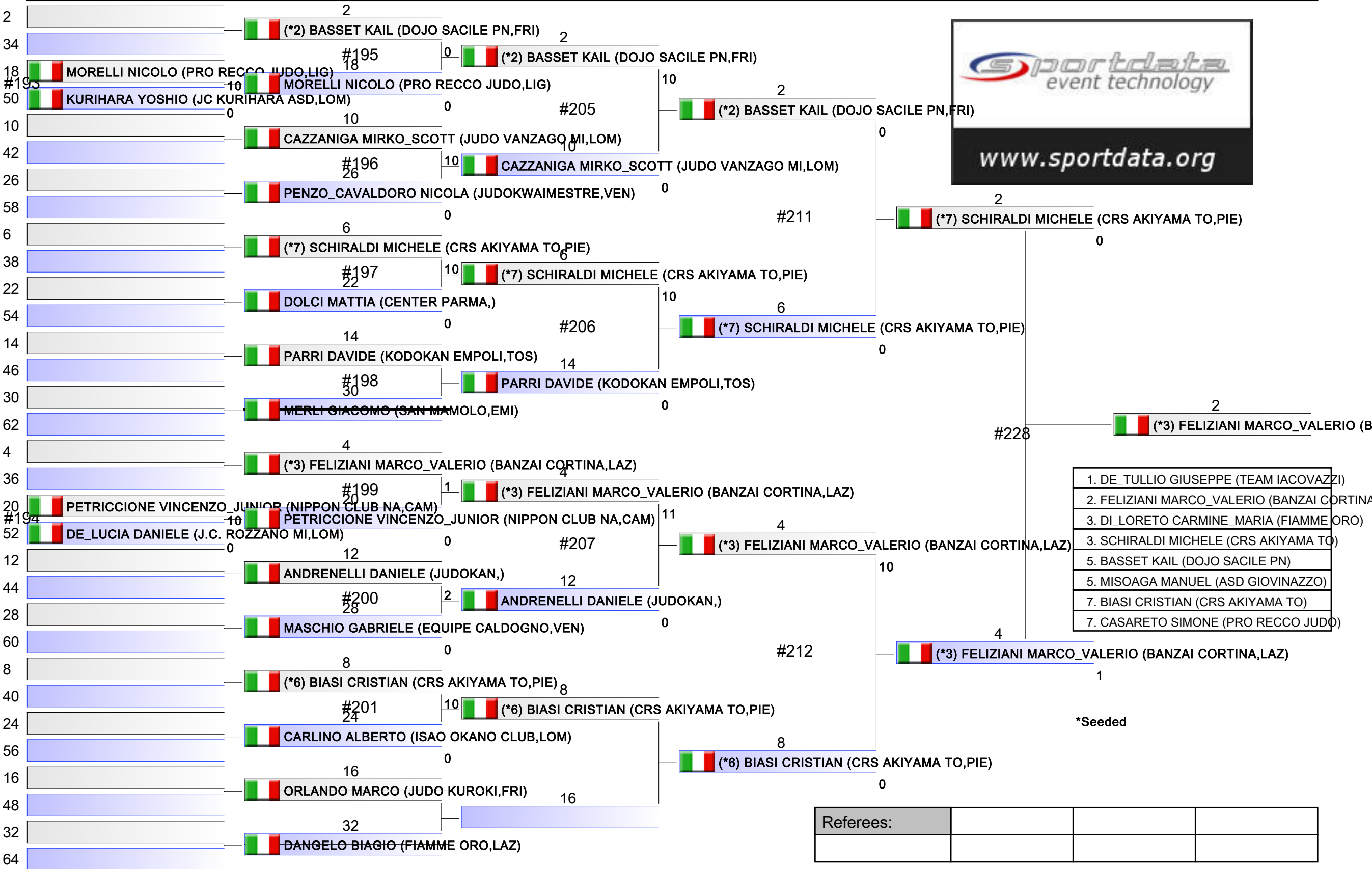

U36 M -66 KG

XXVII ALPE ADRIA GRAND PRIX JUN/SEN

Tatami

Pool
1,2

(c)sportdata GmbH & Co KG 2000-2022 (2022-10-01 18:46) v 9.9.0 build 1 (2022-09-21) License: Online_Event_ID-628_XXVIIALPEADRIAGRANDPRIXJUNSEN (expire 2022-10-15)

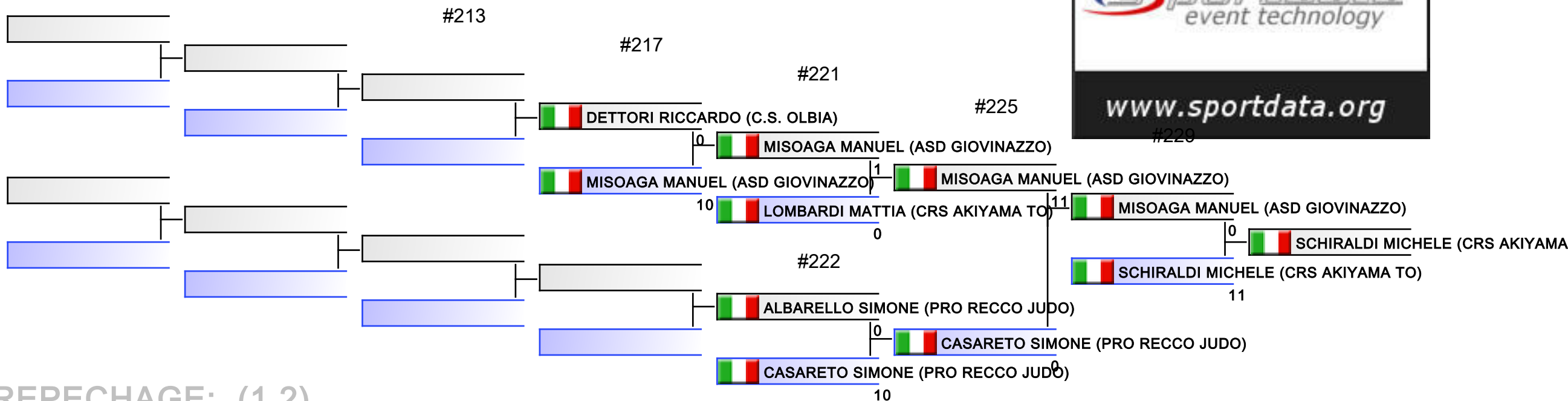

REPECHAGE: (1,2)

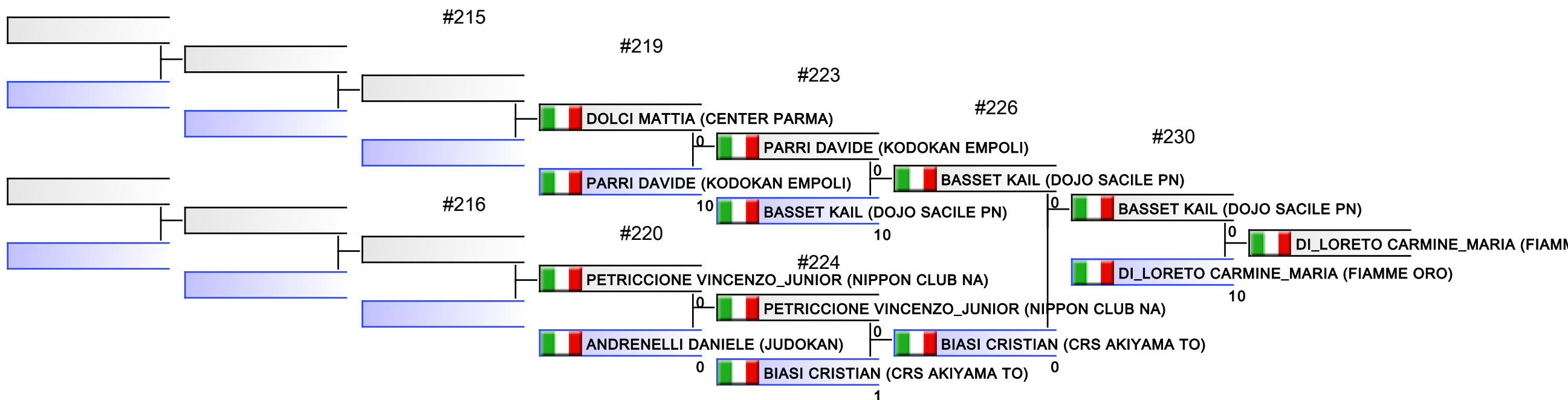

Referees:							
-----------	--	--	--	--	--	--	--

U36 M -73 KG

XXVII ALPE ADRIA GRAND PRIX JUN/SEN, Via delle Scienze 100, 33100, Udine ITA, ITA

Tatami

Pool
2/2

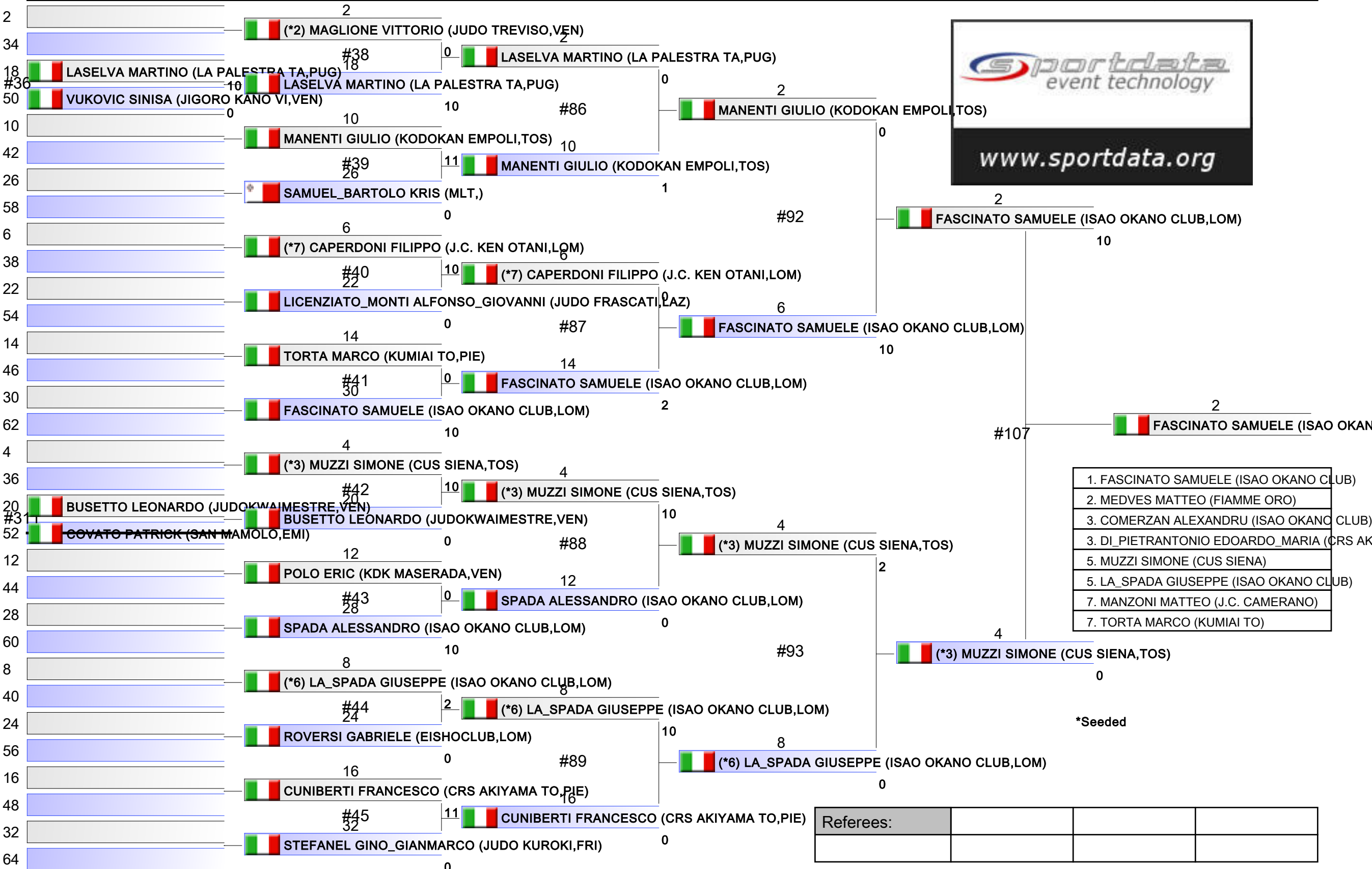

1. FASCINATO SAMUELE (ISAO OKANO CLUB)
2. MEDVES MATTEO (FIAMME ORO)
3. COMERZAN ALEXANDRU (ISAO OKANO CLUB)
3. DI_PIETRANTONIO EDOARDO MARIA (CRS AKIYAMA TO, PIE)
5. MUZZI SIMONE (CUS SIENA)
5. LA_SPADA GIUSEPPE (ISAO OKANO CLUB)
7. MANZONI MATTEO (J.C. CAMERANO)
7. TORTA MARCO (KUMIAI TO)

Referees:			

U36 M -73 KG

XXVII ALPE ADRIA GRAND PRIX JUN/SEN, Via delle Scienze 100, 33100, Udine ITA, ITA

Tatami

Pool
2/2

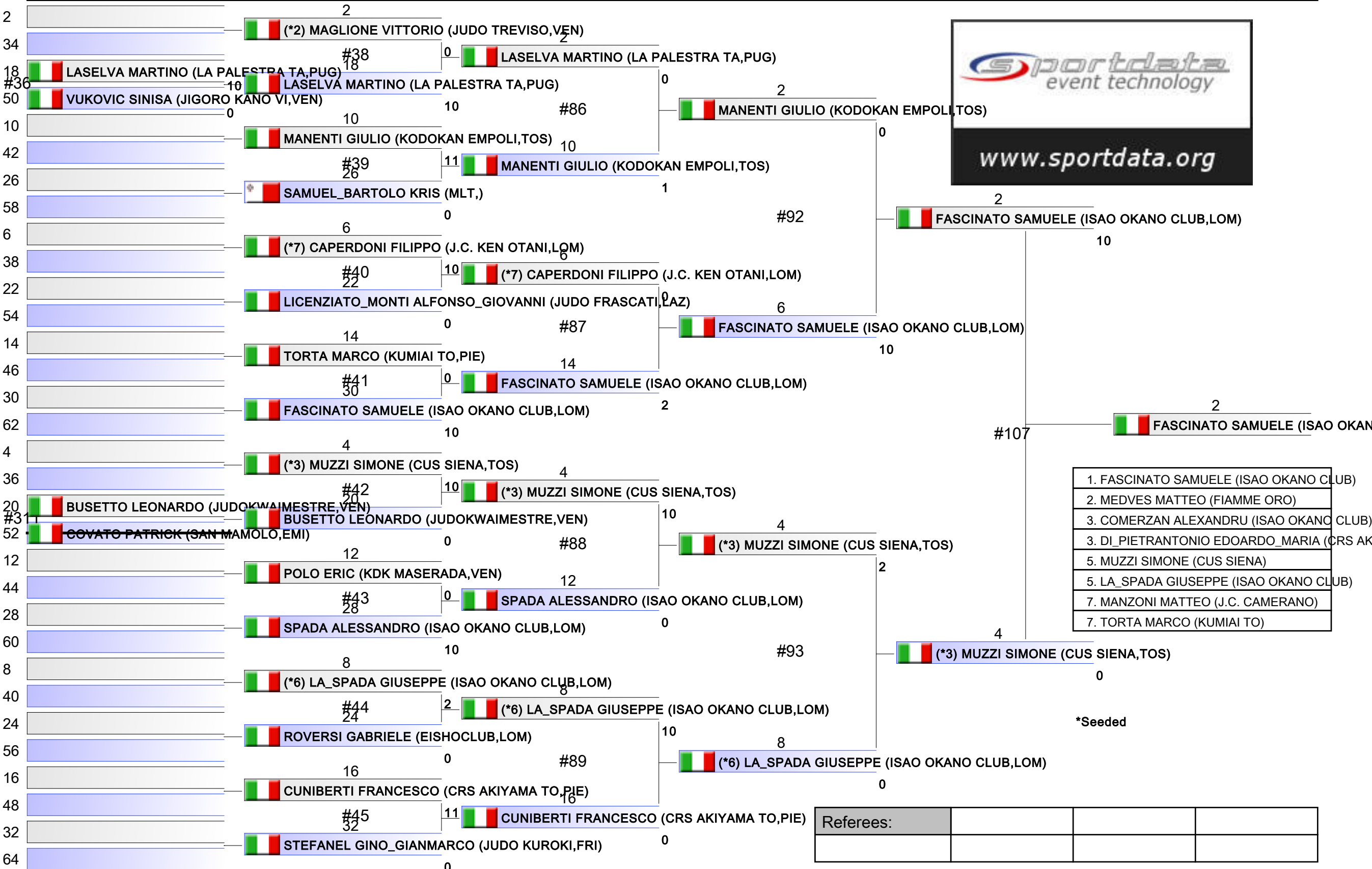

- | |
|--|
| 1. FASCINATO SAMUELE (ISAO OKANO CLUB) |
| 2. MEDVES MATTEO (FIAMME ORO) |
| 3. COMERZAN ALEXANDRU (ISAO OKANO CLUB) |
| 3. DI_PIETRANTONIO EDOARDO_MARIA (CRS AKIYAMA TO, PIE) |
| 5. MUZZI SIMONE (CUS SIENA) |
| 5. LA_SPADA GIUSEPPE (ISAO OKANO CLUB) |
| 7. MANZONI MATTEO (J.C. CAMERANO) |
| 7. TORTA MARCO (KUMIAI TO) |

*Seeded

Referees:			

U36 M -81 KG

XXVII ALPE ADRIA GRAND PRIX JUN/SEN, Via delle Scienze 100, 33100, Udine ITA, ITA

Tatami

Pool
1/1

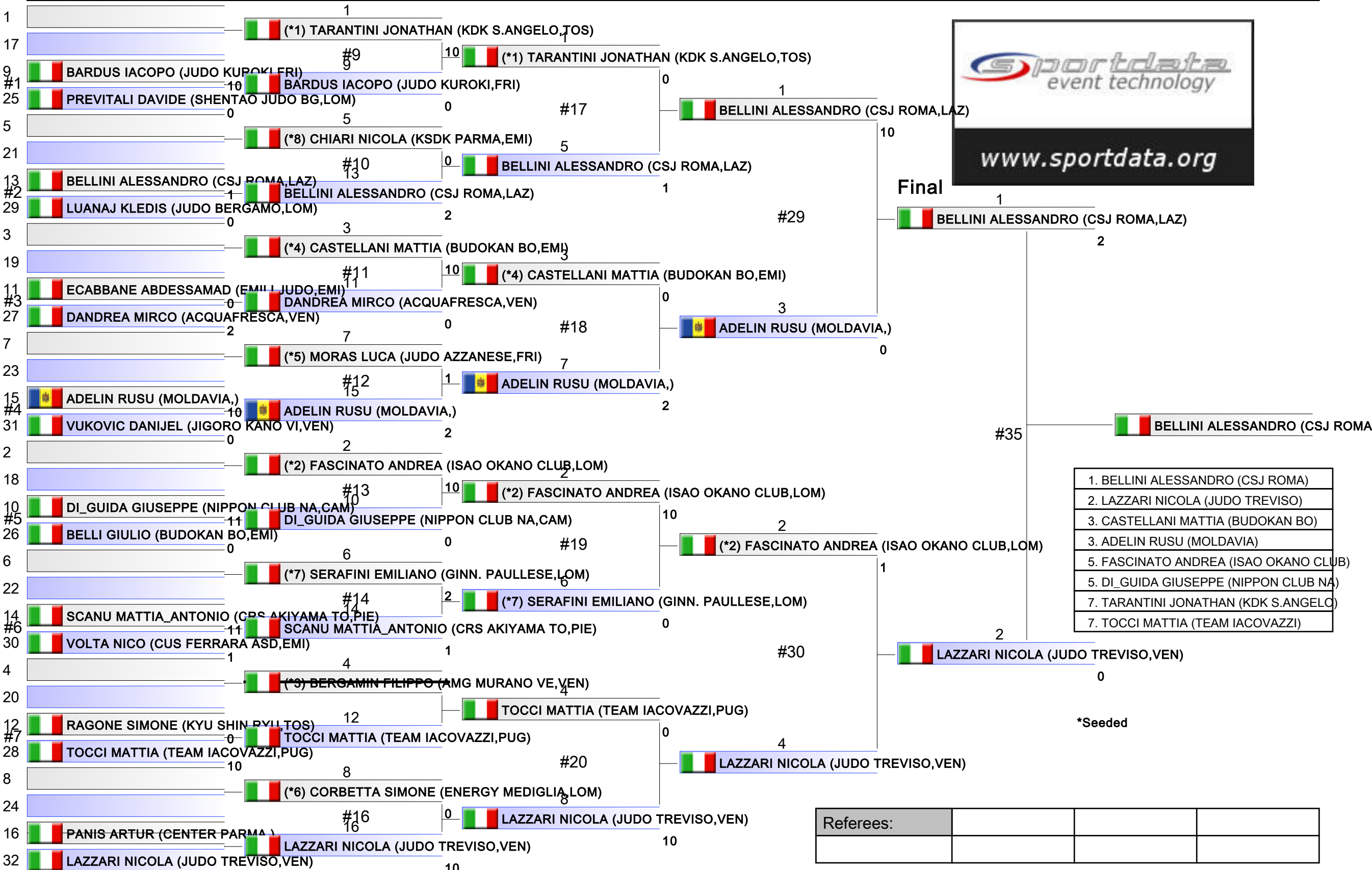

Referees:			

U36 M -81 KG

XXVII ALPE ADRIA GRAND PRIX JUN/SEN

(c)sportdata GmbH & Co KG 2000-2022 (2022-10-01 18:46) v 9.9.0 build 1 (2022-09-21) License: Online_Event_ID-628_XXVIIALPEADRIAGRANDPRIXJUNSEN (expire 2022-10-15)

Tatami

Pool
1

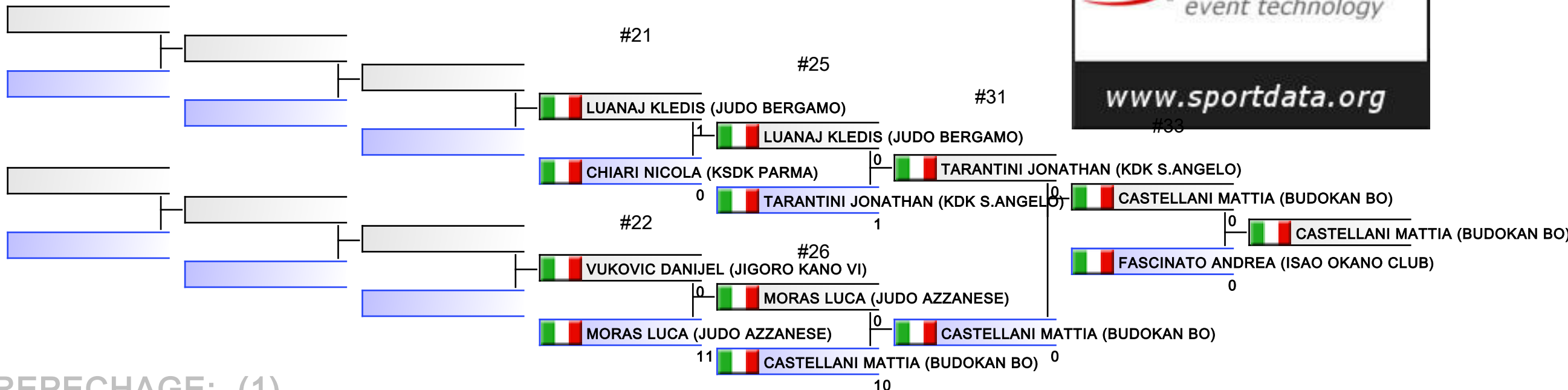

REPECHAGE: (1)

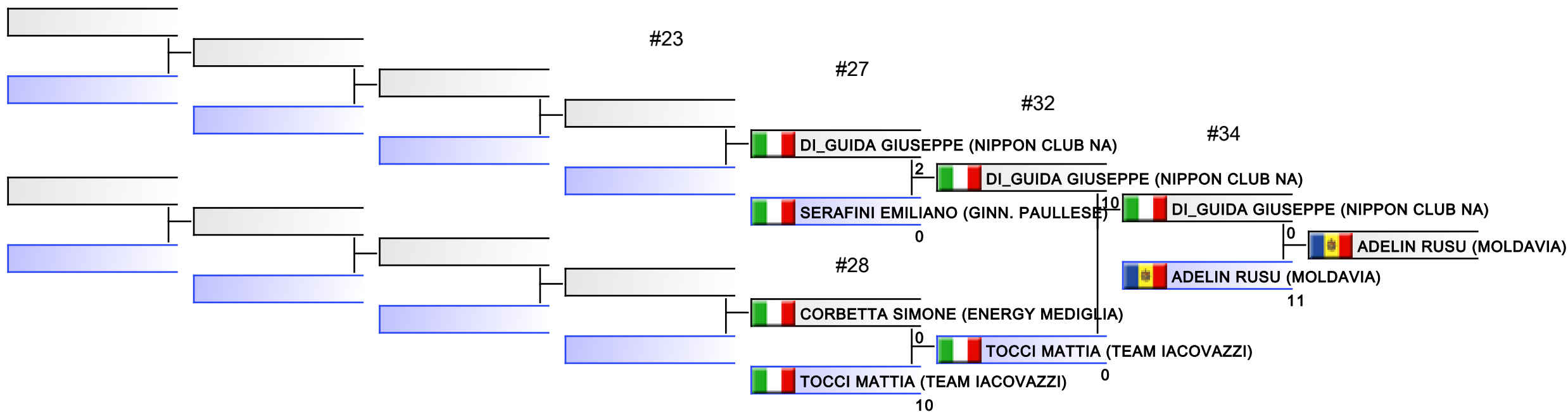

Referees:							
-----------	--	--	--	--	--	--	--

U36 M -90 KG

XXVII ALPE ADRIA GRAND PRIX JUN/SEN, Via delle Scienze 100, 33100, Udine ITA, ITA

Tatami

Pool
1/1

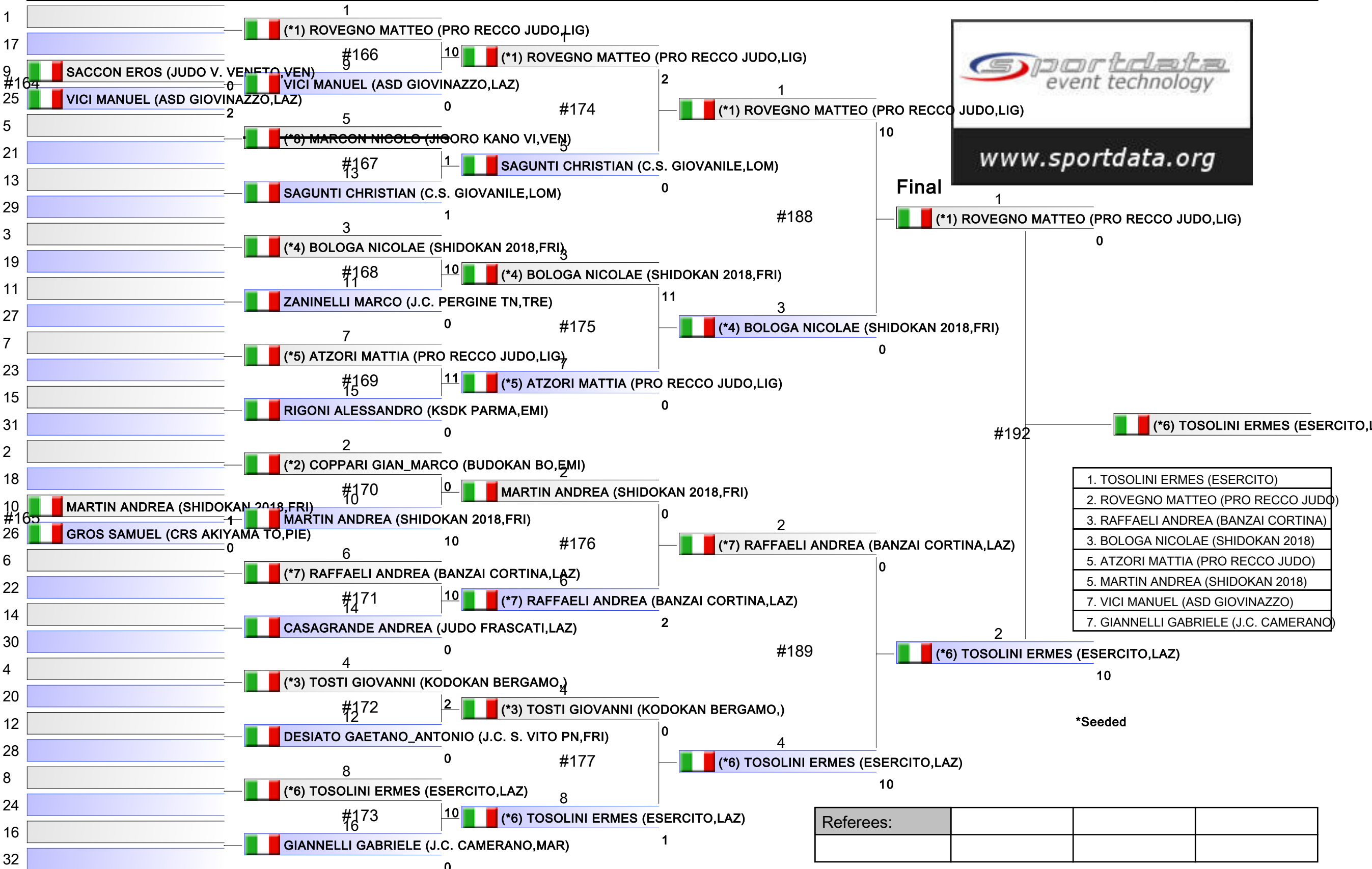

U36 M -90 KG

XXVII ALPE ADRIA GRAND PRIX JUN/SEN

(c)sportdata GmbH & Co KG 2000-2022 (2022-10-01 18:46) v 9.9.0 build 1 (2022-09-21) License: Online_Event_ID-628_XXVIIALPEADRIAGRANDPRIXJUNSEN (expire 2022-10-15)

Tatami

Pool
1

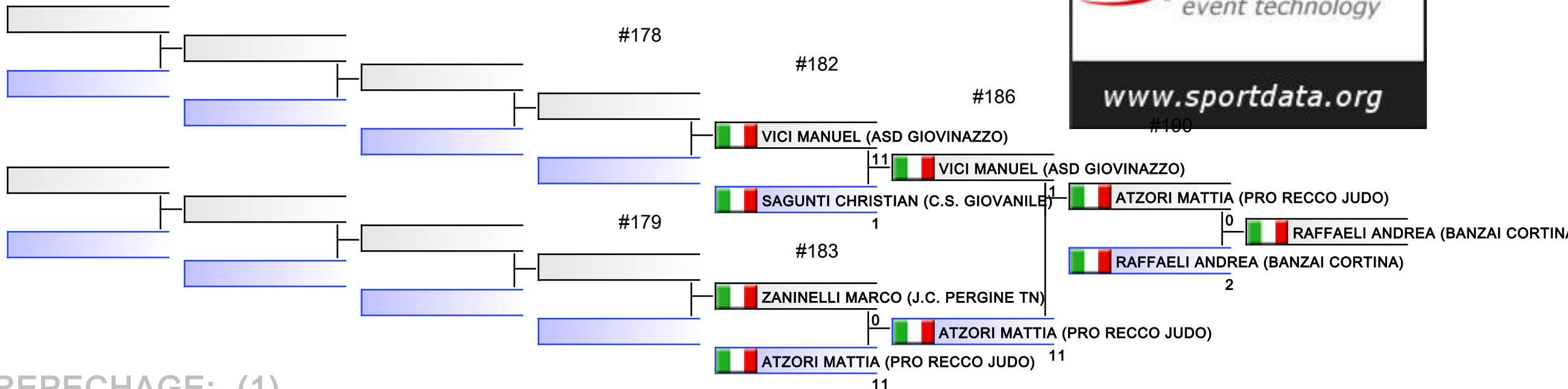

REPECHAGE: (1)

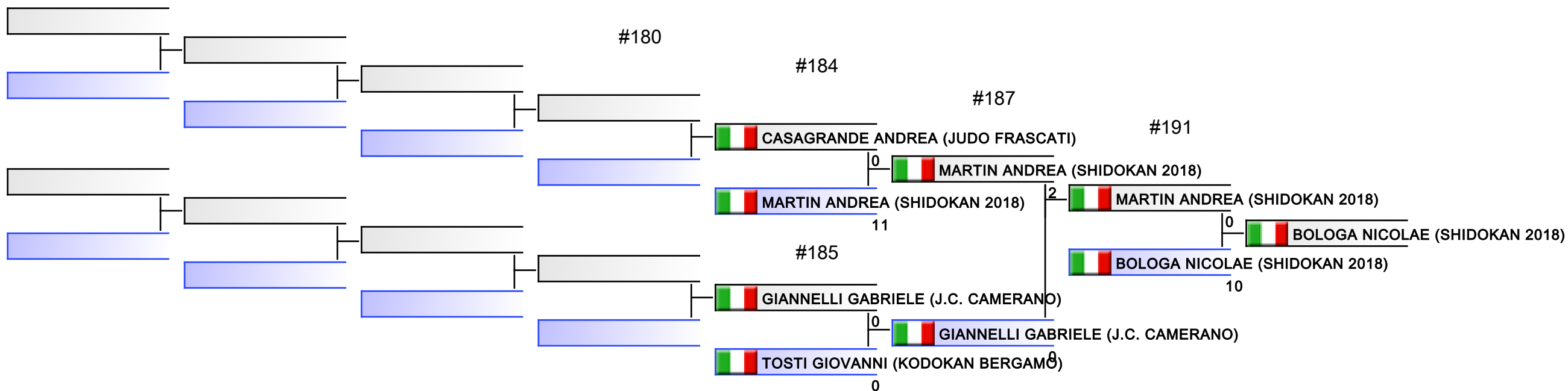

Referees:							
-----------	--	--	--	--	--	--	--

U36 M -100 KG - Round Robin (each against each)

XXVII ALPE ADRIA GRAND PRIX JUN/SEN, Via delle Scienze 100, 33100, Udine ITA, ITA

Tatami
Pool
1/1

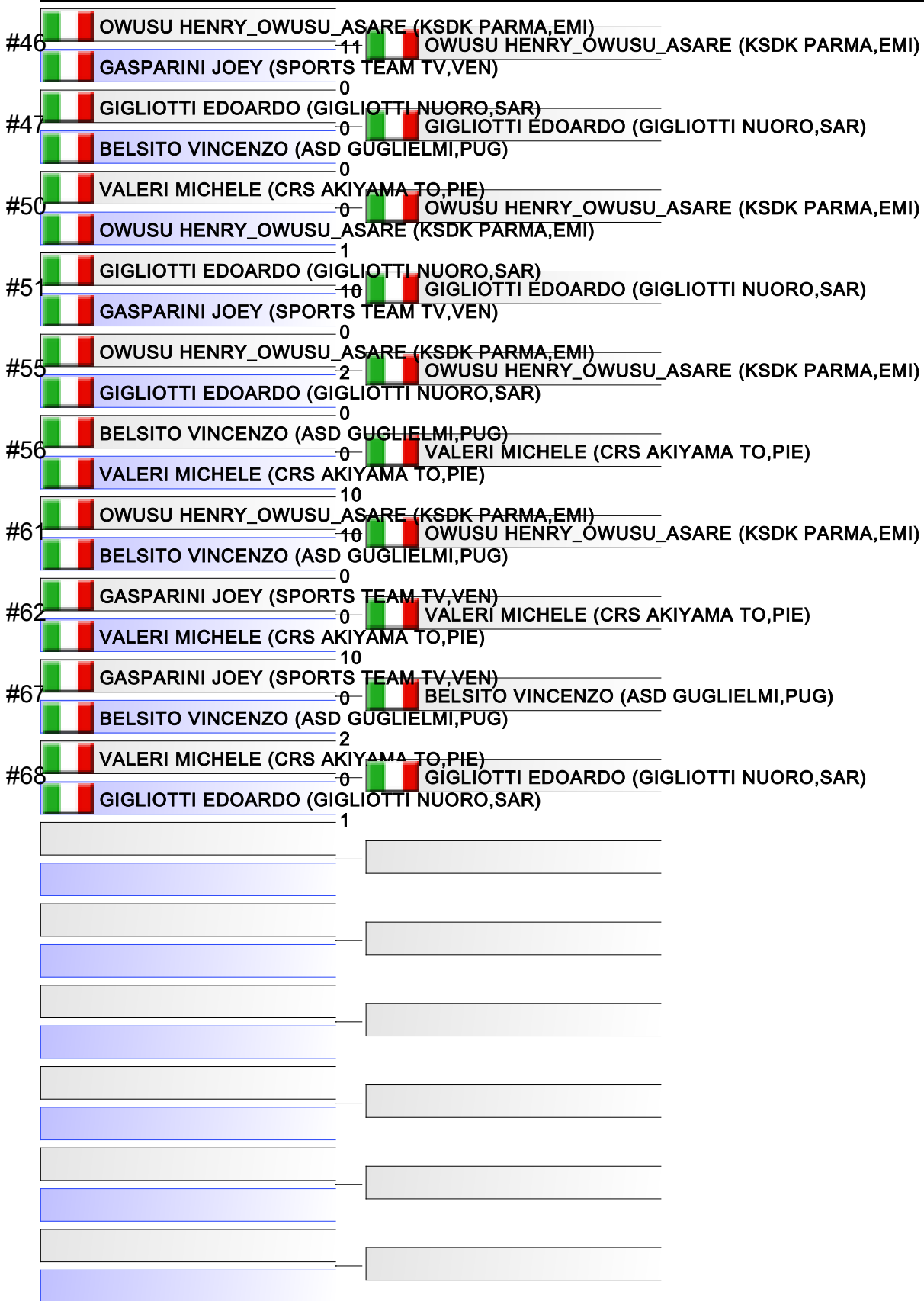

- | |
|---|
| 1. OWUSU HENRY_OWUSU_ASARE (KSDK PARMA,EMI) |
| 2. GIGLIOTTI EDOARDO (GIGLIOTTI NUORO,SAR) |
| 3. VALERI MICHELE (CRS AKIYAMA TO,PIE) |
| 4. BELSITO VINCENZO (ASD GUGLIELMI,PUG) |
| 5. GASPARINI JOEY (SPORTS TEAM TV,VEN) |
| |
| |
| |

U36 M +100 KG

XXVII ALPE ADRIA GRAND PRIX JUN/SEN, Via delle Scienze 100, 33100, Udine ITA, ITA

Tatami

Pool
1/1

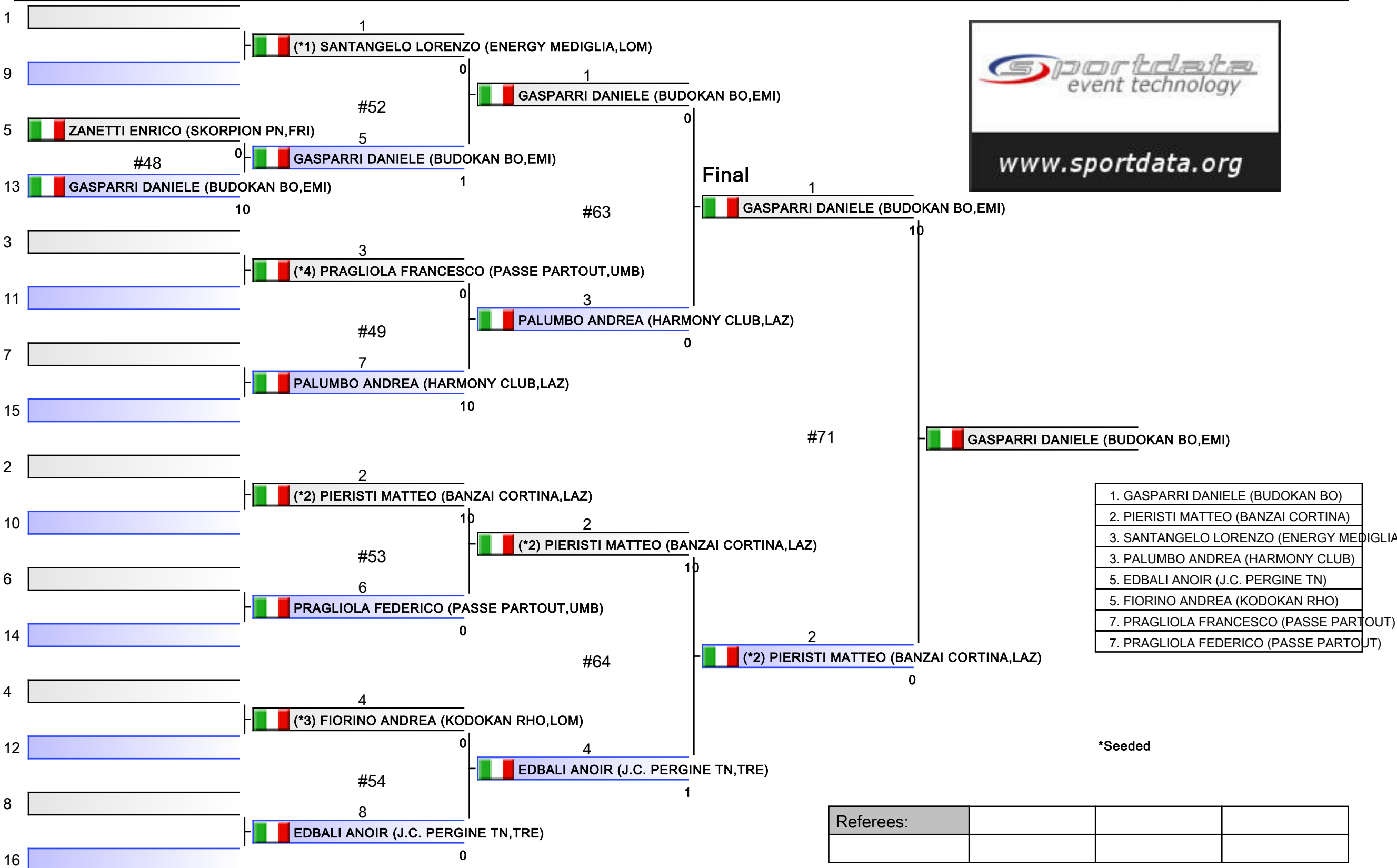

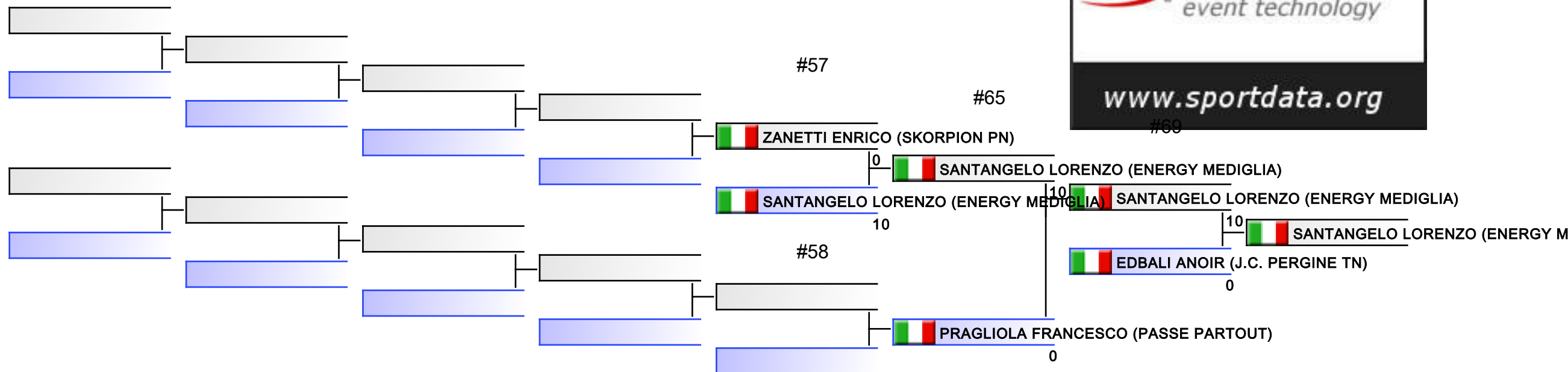

REPECHAGE: (1)

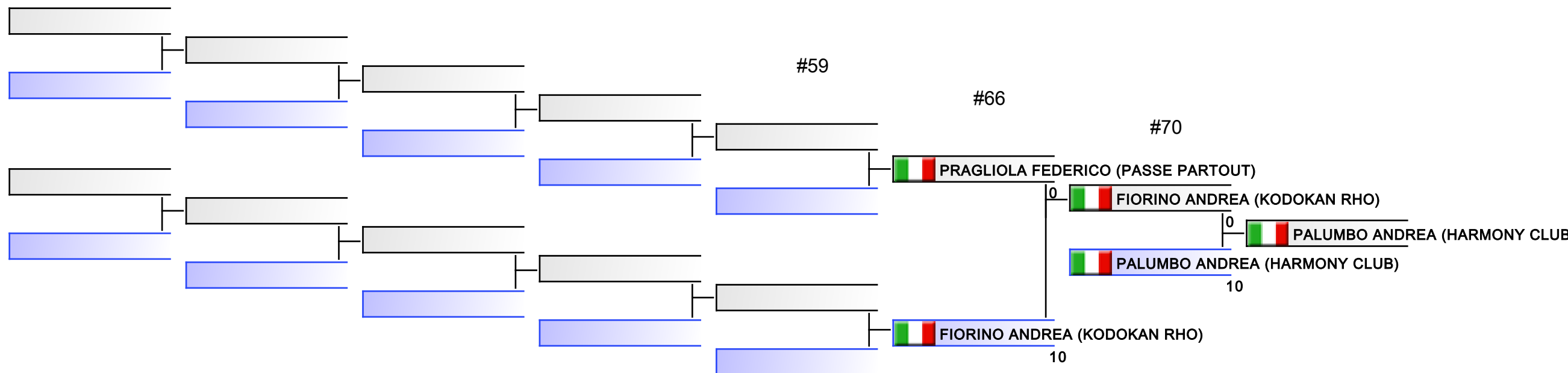

Referees:							
-----------	--	--	--	--	--	--	--



Official Results

XXVII ALPE ADRIA GRAND PRIX JUN/SEN - 2022-10-01

U36 F +78 KG					
Cl.	Atleta		Società	P.ti	
1	GHETTI ELEONORA	1997-02-04	A.S.DILETTANTISTICA JUDO MESTRE 2001	05VE1746	10
2	ROITERO FRANCESCA	1997-09-20	ASSOCIAZIONE SPORTIVA DILETTANTISTICA SKORPION CLUB LIBERTAS PORDENONE	06PN0282	8
3	GIANNELLI SARA	2002-05-09	JUDO CLUB CAMERANO ASSOCIAZIONE SPORTIVA DILETTANTISTICA	11AN0160	6
3	GIORDANO ALESSIA	2001-03-18	A.S.DILETTANTISTICA JUDO TEAM IACOVAZZI	16BA3642	6
5	OSTI CATERINA	2000-04-07	A.S.DILETTANTISTICA BUDOKAN ISTITUTE BOLOGNA	08BO1292	4
5	TURCANU MIHAELA	2000-12-25	A.S.DILETTANTISTICA EQUIPE EMILIA JUDO	08RE3460	4

U36 F -48 KG					
Cl.	Atleta		Società	P.ti	
1	GUARDUCCI ELENA	2004-07-26	C.R.S. AKIYAMA SOCIETA SPORTIVA DILETTANTISTICA A R.L.	01TO0430	10
2	DI STEFANO MARIA	2004-10-22	A.S.DILETTANTISTICA PRO RECCO JUDO	07GE0173	8
3	PLATANIA AURORA	2005-12-27	ASSOCIAZIONE SPORTIVA DILETTANTISTICA DYNAMIC CENTER GRAVINA	19CT0745	6
3	GIORDANO ONDA INDIA	1999-07-27	ISAO OKANO CLUB 97 ASSOCIAZIONE SPORTIVA DILETTANTISTICA	03MI1448	6
5	CAUCHI KIRSTY	2004-06-16	MALTA JUDO FEDEARTION		4
5	CHIARILLI MATILDE	1995-12-12	CENTRO SPORTIVO BUDOKAI ASSOCIAZIONE SPORTIVA DILETTANTISTICA	13AQ0362	4

U36 F -52 KG					
Cl.	Atleta		Società	P.ti	
1	FINESTRONE ILARIA	2005-06-20	A.S.DILETTANTISTICA JUDO TEAM IACOVAZZI	16BA3642	10
2	ZUCCARO AGNESE	2005-12-04	A.S.DILETTANTISTICA GIROLAMO GIOVINAZZO	12RM3376	8
3	CRESCINI ELEONORA	1999-03-09	KYU SHIN DO KAI PARMA ASSOCIAZIONE SPORTIVA DILETTANTISTICA	08PR1231	6
3	CITTARO SOFIA	2001-12-01	A.S.DILETTANTISTICA POLISPORTIVA DLF UDINE	06UD0736	6
5	FERRACINI EMMA	2003-07-25	ASSOCIAZIONE SPORTIVA DILETTANTISTICA JUDO VANZAGO	03MI3079	4
5	PANZANI REBECCA	1996-08-27	A.S.DILETTANTISTICA EQUIPE JUDO CALDOGNO	05VI3911	4
7	AZIZ NISSRIN	2001-02-14	ASD E APS JIGORO KANO TORINO	01TO1222	2
7	FARINA VERONICA	1999-06-01	ASSOCIAZIONE SPORTIVA DILETTANTISTICA JUDO FRASCATI	12RM0360	2

U36 F -57 KG					
Cl.	Atleta		Società	P.ti	
1	SCIACOVELLI MICAELA	2004-04-28	LA PALESTRA ASSOCIAZIONE SPORTIVA DILETTANTISTICA	16TA2640	10

Official Results / XXVII ALPE ADRIA GRAND PRIX JUN/SEN - 2022-10-01

2	DE NARDI ANGELA	2004-10-18	ASSOCIAZIONE SPORTIVA DILETTANTISTICA POLISPORTIVA TAMAI SEZIONE JUDO LIBERTAS	06PN1057	8
3	RIPANDELLI FRANCESCA	1992-01-04	A.S.DILETTANTISTICA JUDO PRENESTE G. CASTELLO	12RM0163	6
3	RUSSO SAVITA	2005-05-18	JUDO CLUB KOIZUMI SCICLI ASSOCIAZIONE SPORTIVA DILETTANTISTICA	19RG0746	6
5	CITTARO ELISA	1993-02-08	A.S.DILETTANTISTICA POLISPORTIVA DLF UDINE	06UD0736	4
5	CANNARA GIORGIA	2003-06-17	A.S.DILETTANTISTICA GIROLAMO GIOVINAZZO	12RM3376	4
7	TRABUJO ALICE	2003-07-05	A.S.DILETTANTISTICA JUDO MESTRE 2001	05VE1746	2
7	BRAGAGNOLO GIORGIA	2002-05-31	ISAO OKANO CLUB 97 ASSOCIAZIONE SPORTIVA DILETTANTISTICA	03MI1448	2
9	MARTUCCI MARIA ROSARIA	2004-07-19	A.S. DILETTANTISTICA STAR JUDO CLUB	15NA1406	0
9	DEMATTE ANGELICA	2004-08-18	ASSOCIAZIONE SPORTIVA DILETTANTISTICA JUDO SAN	04TN2775	0
9	DI FILIPPO ALESSANDRA	2001-03-14	ACCADEMIA ARTI MARZIALI A.S.DILETTANTISTICA	03BG4194	0

U36 F -63 KG

Cl.	Atleta		Società		P.ti
1	PALUMBO ANTONIETTA	2003-09-18	A.S. DILETTANTISTICA STAR JUDO CLUB	15NA1406	10
2	FROSONI GIULIA	2003-03-06	ASSOCIAZIONE SPORTIVA DILETTANTISTICA CENTRO SCUOLE JUDO	12RM2292	8
3	ZINCHENKO YANA	2003-05-23	ASSOCIAZIONE SPORTIVA DILETTANTISTICA JUDO BERGAMO	03BG1886	6
3	SCANO LAURA	1995-02-22	A.S.DILETTANTISTICA POLISPORTIVA DLF UDINE	06UD0736	6
5	FOLTRAN MARINA	2004-01-12	ASSOCIAZIONE SPORTIVA DILETTANTISTICA POLISPORTIVA TAMAI SEZIONE JUDO LIBERTAS	06PN1057	4
5	TAGLIABUE MATILDE	2002-06-24	JUDO CLUB LISSONE ASSOCIAZIONE SPORTIVA DILETTANTISTICA	03MI0219	4
7	TOSO MICOL	2001-11-29	ARTI MARZIALI GIAPPONESI JUDO MURANO ASSOCIAZIONE SPORTIVA DILETTANTISTICA	05VE0101	2
7	PEDE STEFANIA	2005-05-08	C.R.S. AKIYAMA SOCIETA SPORTIVA DILETTANTISTICA A R.L.	01TO0430	2
9	SIBILLA GIORGIA	2005-09-20	C.R.S. AKIYAMA SOCIETA SPORTIVA DILETTANTISTICA A R.L.	01TO0430	0
9	SPOLTI ELISA	2000-10-19	ENERGY MEDIGLIA PALESTRE S.S. DILETTANTISTICA A R.L.	03MI3491	0
9	CATANIA FRANCESCA	2003-08-02	MALTA JUDO FEDEARTION		0
9	BOSCAIA GIULIA	2002-05-18	ASSOCIAZIONE SPORTIVA DILETTANTISTICA POLISPORTIVA TAMAI SEZIONE JUDO LIBERTAS	06PN1057	0
9	PIAGGIO MICHELA	1998-01-25	A.S.DILETTANTISTICA PRO RECCO JUDO	07GE0173	0

U36 F -70 KG

Cl.	Atleta		Società		P.ti
1	ONDEI SERENA	2005-06-06	ASSOCIAZIONE SPORTIVA DILETTANTISTICA JUDO BERGAMO	03BG1886	10
2	PICCOLI AGNESE	1991-07-31	A.S.DILETTANTISTICA POLISPORTIVA DLF UDINE	06UD0736	8
3	AUTIERO ILONA	2004-01-25	ENERGY MEDIGLIA PALESTRE S.S. DILETTANTISTICA A R.L.	03MI3491	6
3	CAMPANELLA EMANUELA	1997-10-02	A.S.DILETTANTISTICA PRO RECCO JUDO	07GE0173	6
5	SIMEOLI SARA	1997-08-21	ASSOCIAZIONE SPORTIVA DILETTANTISTICA MEETING JUDO KARATE	15NA0265	4

U36 F -78 KG

Cl.	Atleta		Società		P.ti
1	SALVADORI MARISOL	2004-10-27	ASSOCIAZIONE SPORTIVA DILETTANTISTICA JUDO TREVISO	05TV0076	10

U36 M +100 KG					
Cl.	Atleta		Società		P.ti
1	GASPARRI DANIELE	1998-09-07	A.S.DILETTANTISTICA BUDOKAN ISTITUTE BOLOGNA	08BO1292	10
2	PIERISTI MATTEO	2001-12-23	A.S. DILETTANTISTICA BANZAI CORTINA ROMA	12RM0162	8
3	SANTANGELO LORENZO	1999-05-05	ENERGY MEDIGLIA PALESTRE S.S. DILETTANTISTICA A R.L.	03MI3491	6
3	PALUMBO ANDREA	2002-12-06	HARMONY CLUB A.S.DILETTANTISTICA	12RM4079	6
5	EDBALI ANOIR	1997-03-22	A.S.DILETTANTISTICA JUDO CLUB PERGINE	04TN1017	4
5	FIORINO ANDREA	1991-10-18	A.S.DILETTANTISTICA KODOKAN RHO	03MI3974	4
7	PRAGLIOLA FRANCESCO	1998-07-01	A.S.DILETTANTISTICA JUDO PASSE-PARTOUT TERNI	10TR1610	2
7	PRAGLIOLA FEDERICO	2003-04-02	A.S.DILETTANTISTICA JUDO PASSE-PARTOUT TERNI	10TR1610	2
9	ZANETTI ENRICO	1999-07-11	ASSOCIAZIONE SPORTIVA DILETTANTISTICA SKORPION CLUB LIBERTAS PORDENONE	06PN0282	0

U36 M -100 KG					
Cl.	Atleta		Società		P.ti
1	OWUSU HENRY OWUSU ASARE	2004-05-11	KYU SHIN DO KAI PARMA ASSOCIAZIONE SPORTIVA DILETTANTISTICA	08PR1231	10
2	GIGLIOTTI EDOARDO	1992-02-16	A.S.DILETTANTISTICA POLISP. GIGLIOTTI TEAM NUORO	20NU3244	8
3	VALERI MICHELE	2000-04-04	C.R.S. AKIYAMA SOCIETA SPORTIVA DILETTANTISTICA A R.L.	01TO0430	6
4	BELSITO VINCENZO	1992-09-27	A.S. DILETTANTISTICA GUGLIELMI	16BT0409	6
5	GASPARINI JOEY	2002-09-11	ASSOCIAZIONE SPORTIVA DILETTANTISTICA SPORTS TEAM	05TV0735	4

U36 M -60 KG					
Cl.	Atleta		Società		P.ti
1	MANFERLOTTI VINCENZO	2004-09-15	ASSOCIAZIONE SPORTIVA DILETTANTISTICA NIPPON CLUB	15NA1418	10
2	ANDREINI PIETRO	2004-08-08	C.R.S. AKIYAMA SOCIETA SPORTIVA DILETTANTISTICA A R.L.	01TO0430	8
3	DI CLEMENTE ALESSIO	1997-01-29	A.S.DILETTANTISTICA JUDO KODOKAN EMPOLI	09FI0231	6
3	ROVATI YURI	2001-12-16	ISAO OKANO CLUB 97 ASSOCIAZIONE SPORTIVA DILETTANTISTICA	03MI1448	6
5	PALUMBO DOMENICO	2004-08-28	A.S.DILETTANTISTICA NEW CRAZY FITNESS	15CE4029	4
5	PORCEDDU FEDERICO	1996-08-12	A.S. DILETTANTISTICA BANZAI CORTINA ROMA	12RM0162	4
7	RAFANIELLO LUCA	2001-09-20	ASSOCIAZIONE SPORTIVA DILETTANTISTICA JUDOKWAI MESTRE	05VE0281	2
7	PERESSIN ALBERTO	2003-11-03	ASSOCIAZIONE SPORTIVA DILETTANTISTICA JUDO CARUGATE	03MI1974	2
9	CONVERSO RUBEN CORRADO	2004-01-28	ASSOCIAZIONE SPORTIVA DILETTANTISTICA CENTRO SCUOLE JUDO	12RM2292	0
10	SOFIA RICCARDO	2004-12-09	ASSOCIAZIONE SPORTIVA DILETTANTISTICA JUDO AZZANESE	06PN0354	0
10	DEIANA FEDERICO	1993-11-02	ASSOCIAZIONE DILETTANTISTICA SPORTIVA CENTRO SPORTIVO OLBIA	20SS1532	0
10	PIPPA ALESSANDRO	2002-08-13	ASSOCIAZIONE SPORTIVA DILETTANTISTICA NIPPON CLUB	15NA1418	0
10	JELIC ALEXANDER	2005-02-04	C.R.S. AKIYAMA SOCIETA SPORTIVA DILETTANTISTICA A R.L.	01TO0430	0
10	ROMIO SEBASTIANO	2004-08-14	ASSOCIAZIONE SPORTIVA DILETTANTISTICA JIGORO KANO JUDO CLUB VICENZA	05VI0079	0
10	BIFFI ANDREA	2003-11-16	ASSOCIAZIONE SPORTIVA DILETTANTISTICA JUDO BERGAMO	03BG1886	0
10	MAGGIONI SIMONE	1997-08-14	ASSOCIAZIONE SPORTIVA DILETTANTISTICA SHENTAO SCUOLA ARTI MARZIALI	03BG2268	0
17	LOVATI MATTEO	2004-02-22	KUMIAI S.S. DILETTANTISTICA A R.L.	01TO3089	0
17	VERDECCHIA RICCARDO	2003-10-02	JUDO CLUB SAKURA OSIMO ASSOCIAZIONE SPORTIVA DILETTANTISTICA	11AN0063	0

Official Results / XXVII ALPE ADRIA GRAND PRIX JUN/SEN - 2022-10-01

17	GUBIANI BORIS	1992-05-27	ASSOCIAZIONE SPORTIVA DILETTANTISTICA JUDO KUROKI	06UD0623	0
17	DI DONATO DARIO	2004-02-16	A.S. DILETTANTISTICA STAR JUDO CLUB	15NA1406	0
17	BEVILACQUA MATTEO FERNANDO	2002-06-19	ASSOCIAZIONE SPORTIVA DILETTANTISTICA JUDO CLUB SEGRATE	03MI0728	0
17	ALGIERI SAMUELE	2005-04-26	KUMIAI S.S. DILETTANTISTICA A R.L.	01TO3089	0
17	CADONI NICOLO	2002-05-25	ASSOCIAZIONE DILETTANTISTICA SPORTIVA CENTRO SPORTIVO OLBIA	20SS1532	0

U36 M -66 KG

Cl.	Atleta		Società		P.ti
1	DE TULLIO GIUSEPPE	2002-10-13	A.S.DILETTANTISTICA JUDO TEAM IACOVAZZI	16BA3642	10
2	FELIZIANI MARCO VALERIO	2001-12-10	A.S. DILETTANTISTICA BANZAI CORTINA ROMA	12RM0162	8
3	SCHIRALDI MICHELE	2002-05-12	C.R.S. AKIYAMA SOCIETA SPORTIVA DILETTANTISTICA A R.L.	01TO0430	6
3	DI LORETO CARMINE MARIA	1993-06-12	G.S.FIAMME ORO ROMA	12RM0061	6
5	MISOAGA MANUEL	2004-03-20	A.S.DILETTANTISTICA GIROLAMO GIOVINAZZO	12RM3376	4
5	BASSET KAIL	2001-01-06	ASSOCIAZIONE SPORTIVA DILETTANTISTICA DOJO SACILE	06PN1518	4
7	CASARETO SIMONE	2001-10-18	A.S.DILETTANTISTICA PRO RECCO JUDO	07GE0173	2
7	BIASI CRISTIAN	2004-12-10	C.R.S. AKIYAMA SOCIETA SPORTIVA DILETTANTISTICA A R.L.	01TO0430	2
9	LOMBARDI MATTIA	2001-08-08	C.R.S. AKIYAMA SOCIETA SPORTIVA DILETTANTISTICA A R.L.	01TO0430	0
10	PALAIÀ GIAMMARCO	2002-03-31	HARMONY CLUB A.S.DILETTANTISTICA	12RM4079	0
10	BOTTA MICHELE	2002-12-10	A.S.DILETTANTISTICA KODOKAN LUCANIA BRIENZA	17PZ1743	0
10	ALBARELLO SIMONE	1999-11-25	A.S.DILETTANTISTICA PRO RECCO JUDO	07GE0173	0
10	CAZZANIGA MIRKO SCOTT	1997-12-24	ASSOCIAZIONE SPORTIVA DILETTANTISTICA JUDO VANZAGO	03MI3079	0
10	PARRI DAVIDE	2005-02-22	A.S.DILETTANTISTICA JUDO KODOKAN EMPOLI	09FI0231	0
10	ANDRELLI DANIELE	1992-04-25	A.S.D. JUDOKAN	12RM3409	0
16	DETTORI RICCARDO	2004-03-03	ASSOCIAZIONE DILETTANTISTICA SPORTIVA CENTRO SPORTIVO OLBIA	20SS1532	0
16	NINFO FEDERICO	2005-06-19	ISAO OKANO CLUB 97 ASSOCIAZIONE SPORTIVA DILETTANTISTICA	03MI1448	0
16	CAVALLERI MATTEO	2001-11-08	ASSOCIAZIONE SPORTIVA DILETTANTISTICA JIGORO KANO JUDO CAPIAGO	03CO2449	0
16	CIRACI CHRISTIAN	1996-07-11	JUDO CLUB PARABIAGO DILETTANTISTICA	03MI1744	0
16	CITTADINI LEONARDO	2001-11-30	A.S.DILETTANTISTICA BUDOKAN ISTITUTE BOLOGNA	08BO1292	0
16	MORETTI MARCO	2003-06-17	ARTI MARZIALI GIAPPONESI JUDO MURANO ASSOCIAZIONE SPORTIVA DILETTANTISTICA	05VE0101	0
16	TORRES ALESSIO	1999-09-01	A&R PALESTRE S.S.DILETTANTISTICA A R.L.	06TS3610	0
16	MORELLI NICOLO	2004-04-16	A.S.DILETTANTISTICA PRO RECCO JUDO	07GE0173	0
16	PENZO CAVALDORO NICOLA	1988-07-01	ASSOCIAZIONE SPORTIVA DILETTANTISTICA JUDOKWAI MESTRE	05VE0281	0
16	DOLCI MATTIA	1998-09-26	A.S.D. CENTER PARMA	08PR1187	0
16	PETRICCIONE VINCENZO JUNIOR	2004-12-28	ASSOCIAZIONE SPORTIVA DILETTANTISTICA NIPPON CLUB	15NA1418	0
16	MASCHIO GABRIELE	2003-06-03	A.S.DILETTANTISTICA EQUIPE JUDO CALDOGNO	05VI3911	0
16	CARLINO ALBERTO	2002-06-16	ISAO OKANO CLUB 97 ASSOCIAZIONE SPORTIVA DILETTANTISTICA	03MI1448	0
29	NOCENT FRANCESCO	2004-04-20	ASSOCIAZIONE SPORTIVA DILETTANTISTICA JUDO KUROKI	06UD0623	0
29	MANGINO NICCOLO	2003-12-26	C.R.S. AKIYAMA SOCIETA SPORTIVA DILETTANTISTICA A R.L.	01TO0430	0
29	KURIHARA YOSHIO	2002-03-04	JUDO CLUB KURIHARA ASSOCIAZIONE SPORTIVA DILETTANTISTICA	03MI0184	0
29	DE LUCIA DANIELE	2001-08-06	ASSOCIAZIONE SPORTIVA DILETTANTISTICA JUDO CLUB ROZZANO	03MI0392	0

U36 M -73 KG					
Cl.	Atleta		Società		P.ti
1	FASCINATO SAMUELE	1997-05-17	ISAO OKANO CLUB 97 ASSOCIAZIONE SPORTIVA DILETTANTISTICA	03MI1448	10
2	MEDVES MATTEO	1994-06-20	G.S.FIAMME ORO ROMA	12RM0061	8
3	COMERZAN ALEXANDRU	2002-07-22	ISAO OKANO CLUB 97 ASSOCIAZIONE SPORTIVA DILETTANTISTICA	03MI1448	6
3	DI PIETRANTONIO EDOARDO MARIA	1998-02-11	C.R.S. AKIYAMA SOCIETA SPORTIVA DILETTANTISTICA A R.L.	01TO0430	6
5	MUZZI SIMONE	2000-04-07	C.U.S. SIENA ASSOCIAZIONE SPORTIVA DILETTANTISTICA	09SI0257	4
5	LA SPADA GIUSEPPE	1997-10-03	ISAO OKANO CLUB 97 ASSOCIAZIONE SPORTIVA DILETTANTISTICA	03MI1448	4
7	MANZONI MATTEO	2002-09-10	JUDO CLUB CAMERANO ASSOCIAZIONE SPORTIVA DILETTANTISTICA	11AN0160	2
7	TORTA MARCO	2002-01-07	KUMIAI S.S. DILETTANTISTICA A R.L.	01TO3089	2
9	ANDRIJCZUK AXEL	2002-12-21	SHIDOKAN 2018 A.S.DILETTANTISTICA	06PN4102	0
9	DI RENZO MANNINO STEFANO	1999-04-30	ISAO OKANO CLUB 97 ASSOCIAZIONE SPORTIVA DILETTANTISTICA	03MI1448	0
9	MANENTI GIULIO	2005-08-10	A.S.DILETTANTISTICA JUDO KODOKAN EMPOLI	09FI0231	0
12	TABARINI MATTIA	2004-09-30	EISHO CLUB MILANO SDD SRL	03MI4403	0
12	RIVALETTO DAVIDE	2003-10-06	A.S.DILETTANTISTICA JUDO VITTORIO VENETO	05TV0734	0
12	BONATO ALAN	1998-05-07	A.S.DILETTANTISTICA BUDOKAN ISTITUTE BOLOGNA	08BO1292	0
12	LASELVA MARTINO	2004-03-27	LA PALESTRA ASSOCIAZIONE SPORTIVA DILETTANTISTICA	16TA2640	0
12	CAPERDONI FILIPPO	2004-12-06	JUDO CLUB KEN OTANI-MELEGNANO A.S. DILETTANTISTICA	03MI2133	0
12	SPADA ALESSANDRO	2001-04-30	ISAO OKANO CLUB 97 ASSOCIAZIONE SPORTIVA DILETTANTISTICA	03MI1448	0
12	CUNIBERTI FRANCESCO	2004-12-21	C.R.S. AKIYAMA SOCIETA SPORTIVA DILETTANTISTICA A R.L.	01TO0430	0
19	GIANNONE SIMONE	1989-11-07	A.S.D. JUDO AZZURRO		0
19	MARASTONI MATTHEW PAUL	2002-07-26	ASSOCIAZIONE SPORTIVA DILETTANTISTICA JUDO VALPOLICELLA	05VR1810	0
19	IOVINE LORENZO	2003-03-28	ASSOCIAZIONE SPORTIVA DILETTANTISTICA NIPPON CLUB	15NA1418	0
19	CAROMANI NICOLO	2003-08-20	A.S.D. DOJO EQUIPE BOLOGNA	08BO1093	0
19	GIUNTI ALBERTO	2001-05-07	A.S. DILETTANTISTICA KYU SHIN RYU PRATO	09PO1285	0
19	MAGLIONE VITTORIO	2001-04-08	ASSOCIAZIONE SPORTIVA DILETTANTISTICA JUDO TREVISO	05TV0076	0
19	SAMUEL BARTOLO KRIS	2005-05-28	MALTA JUDO FEDEARTION		0
19	LICENZIATO MONTI ALFONSO GIOVANNI	2002-07-22	ASSOCIAZIONE SPORTIVA DILETTANTISTICA JUDO FRASCATI	12RM0360	0
19	BUSETTO LEONARDO	1992-06-07	ASSOCIAZIONE SPORTIVA DILETTANTISTICA JUDOKWAI MESTRE	05VE0281	0
19	POLO ERIC	1994-02-20	A.S. DILETTANTISTICA JUDO KODOKAN MASERADA SUL PIAVE	05TV1133	0
19	ROVERSI GABRIELE	2003-03-31	EISHO CLUB MILANO SDD SRL	03MI4403	0
19	STEFANEL GINO GIANMARCO	1993-04-07	ASSOCIAZIONE SPORTIVA DILETTANTISTICA JUDO KUROKI	06UD0623	0
31	CUGINI GIACOMO	1997-01-29	ASSOCIAZIONE SPORTIVA DILETTANTISTICA JUDO KUROKI	06UD0623	0
31	VENÈ FEDERICO	2001-05-30	JUDO CLUB SAKURA OSIMO ASSOCIAZIONE SPORTIVA DILETTANTISTICA	11AN0063	0
31	VUKOVIC SINISA	2000-02-20	ASSOCIAZIONE SPORTIVA DILETTANTISTICA JIGORO KANO JUDO CLUB VICENZA	05VI0079	0

U36 M -81 KG					
Cl.	Atleta		Società		P.ti
1	BELLINI ALESSANDRO	2003-07-06	ASSOCIAZIONE SPORTIVA DILETTANTISTICA CENTRO SCUOLE JUDO	12RM2292	10
2	LAZZARI NICOLA	2004-05-08	ASSOCIAZIONE SPORTIVA DILETTANTISTICA JUDO TREVISO	05TV0076	8

Official Results / XXVII ALPE ADRIA GRAND PRIX JUN/SEN - 2022-10-01

3	CASTELLANI MATTIA	1998-02-10	A.S.DILETTANTISTICA BUDOKAN ISTITUTE BOLOGNA	08BO1292	6
3	ADELIN RUSU	2001-02-16	S.S.O.L. MOLDOVA		6
5	FASCINATO ANDREA	2000-06-09	ISAO OKANO CLUB 97 ASSOCIAZIONE SPORTIVA DILETTANTISTICA	03MI1448	4
5	DI GUIDA GIUSEPPE	2002-05-20	ASSOCIAZIONE SPORTIVA DILETTANTISTICA NIPPON CLUB	15NA1418	4
7	TARANTINI JONATHAN	1994-10-11	A.S.DILETTANTISTICA JUDO KODOKAN S.ANGELO	09FI0819	2
7	TOCCI MATTIA	2004-05-07	A.S.DILETTANTISTICA JUDO TEAM IACOVAZZI	16BA3642	2
9	SERAFINI EMILIANO	2000-01-06	A.S.DILETTANTISTICA GINNASTICA PAULLESE	03MI3230	0
10	BARDUS IACOPO	2004-01-15	ASSOCIAZIONE SPORTIVA DILETTANTISTICA JUDO KUROKI	06UD0623	0
10	CHIARI NICOLA	2004-03-02	KYU SHIN DO KAI PARMA ASSOCIAZIONE SPORTIVA DILETTANTISTICA	08PR1231	0
10	DANDREA MIRCO	2003-02-10	ACQUAFRESCA SPORT CENTER A.S.DILETTANTISTICA	05VR3937	0
10	MORAS LUCA	1998-01-08	ASSOCIAZIONE SPORTIVA DILETTANTISTICA JUDO AZZANESE	06PN0354	0
10	SCANU MATTIA ANTONIO	2003-09-18	C.R.S. AKIYAMA SOCIETA SPORTIVA DILETTANTISTICA A R.L.	01TO0430	0
10	CORBETTA SIMONE	2002-10-13	ENERGY MEDIGLIA PALESTRE S.S. DILETTANTISTICA A R.L.	03MI3491	0
16	PREVITALI DAVIDE	2004-08-16	ASSOCIAZIONE SPORTIVA DILETTANTISTICA SHENTAO SCUOLA ARTI MARZIALI	03BG2268	0
16	LUANAJ KLEDIS	2004-08-11	ASSOCIAZIONE SPORTIVA DILETTANTISTICA JUDO BERGAMO	03BG1886	0
16	ECABBANE ABDESSAMAD	2000-09-11	A.S.DILETTANTISTICA EQUIPE EMILIA JUDO	08RE3460	0
16	VUKOVIC DANIJEL	2002-03-13	ASSOCIAZIONE SPORTIVA DILETTANTISTICA JIGORO KANO JUDO CLUB VICENZA	05VI0079	0
16	BELLI GIULIO	1999-09-17	A.S.DILETTANTISTICA BUDOKAN ISTITUTE BOLOGNA	08BO1292	0
16	VOLTA NICO	1998-11-22	C.U.S. FERRARA ASSOCIAZIONE SPORTIVA DILETTANTISTICA	08FE3078	0
16	RAGONE SIMONE	1989-08-04	A.S. DILETTANTISTICA KYU SHIN RYU PRATO	09PO1285	0

U36 M -90 KG



















Cl.	Atleta		Società		P.ti
1	TOSOLINI ERMES	1991-08-19	CENTRO SPORTIVO ESERCITO ROMA	12RM0134	10
2	ROVEGNO MATTEO	1998-12-11	A.S.DILETTANTISTICA PRO RECCO JUDO	07GE0173	8
3	RAFFAELI ANDREA	2003-05-22	A.S. DILETTANTISTICA BANZAI CORTINA ROMA	12RM0162	6
3	BOLOGA NICOLAE	2001-03-28	SHIDOKAN 2018 A.S.DILETTANTISTICA	06PN4102	6
5	ATZORI MATTIA	1995-09-15	A.S.DILETTANTISTICA PRO RECCO JUDO	07GE0173	4
5	MARTIN ANDREA	2003-04-01	SHIDOKAN 2018 A.S.DILETTANTISTICA	06PN4102	4
7	VICI MANUEL	2002-07-18	A.S.DILETTANTISTICA GIROLAMO GIOVINAZZO	12RM3376	2
7	GIANNELLI GABRIELE	2002-05-09	JUDO CLUB CAMERANO ASSOCIAZIONE SPORTIVA DILETTANTISTICA	11AN0160	2
9	SAGUNTI CHRISTIAN	2002-04-03	CENTRO SPORTIVO GIOVANILE - ASSOCIAZIONE SPORTIVA DILETTANTISTICA	03MI0660	0
9	TOSTI GIOVANNI	1998-05-14	A.S.D. KODOKAN JUDO BERGAMO	03BG0986	0
11	ZANINELLI MARCO	1998-10-29	A.S.DILETTANTISTICA JUDO CLUB PERGINE	04TN1017	0
11	RIGONI ALESSANDRO	2004-03-23	KYU SHIN DO KAI PARMA ASSOCIAZIONE SPORTIVA DILETTANTISTICA	08PR1231	0
11	COPPARI GIAN MARCO	1998-03-25	A.S.DILETTANTISTICA BUDOKAN ISTITUTE BOLOGNA	08BO1292	0
11	CASAGRANDE ANDREA	2003-07-30	ASSOCIAZIONE SPORTIVA DILETTANTISTICA JUDO FRASCATI	12RM0360	0
11	DESIATO GAETANO ANTONIO	2004-03-07	ASSOCIAZIONE SPORTIVA DILETTANTISTICA JUDO CLUB SAN VITO	06PN0521	0
16	SACCON EROS	1997-12-13	A.S.DILETTANTISTICA JUDO VITTORIO VENETO	05TV0734	0
16	GROS SAMUEL	2004-04-23	C.R.S. AKIYAMA SOCIETA SPORTIVA DILETTANTISTICA A R.L.	01TO0430	0







Classifica Società Sportive
XXVII ALPE ADRIA GRAND PRIX JUN/SEN - 2022-10-01

<i>Rank</i>	<i>Club</i>	<i>Athlete</i>	<i>1. Place</i>	<i>2. Place</i>	<i>3. Place</i>	<i>5. Place</i>	<i>7. Place</i>	<i>11. Place</i>	<i>Total</i>
1	A.S.DILETTANTISTICA POLISPORTIVA DLF UDINE, 06UD0736, ITA	4	0	1	2	1	0	0	24
2	A.S.DILETTANTISTICA JUDO TEAM IACOVAZZI, 16BA3642, ITA	2	1	0	1	0	0	0	16
	ASSOCIAZIONE SPORTIVA DILETTANTISTICA JUDO BERGAMO, 03BG1886, ITA	2	1	0	1	0	0	0	16
4	A.S.DILETTANTISTICA PRO RECCO JUDO, 07GE0173, ITA	3	0	1	1	0	0	0	14
5	A.S.DILETTANTISTICA JUDO MESTRE 2001, 05VE1746, ITA	2	1	0	0	0	1	0	12
	C.R.S. AKIYAMA SOCIETA SPORTIVA DILETTANTISTICA A R.L., 01TO0430, ITA	3	1	0	0	0	1	0	12
	A.S.DILETTANTISTICA GIROLAMO GIOVINAZZO, 12RM3376, ITA	2	0	1	0	1	0	0	12
	ASSOCIAZIONE SPORTIVA DILETTANTISTICA POLISPORTIVA TAMAI SEZIONE JUDO LIBERTAS, 06PN1057, ITA	3	0	1	0	1	0	0	12
9	LA PALESTRA ASSOCIAZIONE SPORTIVA DILETTANTISTICA, 16TA2640, ITA	1	1	0	0	0	0	0	10
	ASSOCIAZIONE SPORTIVA DILETTANTISTICA JUDO TREVISO, 05TV0076, ITA	1	1	0	0	0	0	0	10
	A.S. DILETTANTISTICA STAR JUDO CLUB, 15NA1406, ITA	2	1	0	0	0	0	0	10

Classifica Società Sportive / XXVII ALPE ADRIA GRAND PRIX JUN/SEN - 2022-10-01

12	 ASSOCIAZIONE SPORTIVA DILETTANTISTICA SKORPION CLUB LIBERTAS PORDENONE, 06PN0282, ITA	1	0	1	0	0	0	0	8
	 ASSOCIAZIONE SPORTIVA DILETTANTISTICA CENTRO SCUOLE JUDO, 12RM2292, ITA	1	0	1	0	0	0	0	8
	 ISAO OKANO CLUB 97 ASSOCIAZIONE SPORTIVA DILETTANTISTICA, 03MI1448, ITA	2	0	0	1	0	1	0	8
15	 JUDO CLUB KOIZUMI SCICLI ASSOCIAZIONE SPORTIVA DILETTANTISTICA, 19RG0746, ITA	1	0	0	1	0	0	0	6
	 JUDO CLUB CAMERANO ASSOCIAZIONE SPORTIVA DILETTANTISTICA, 11AN0160, ITA	1	0	0	1	0	0	0	6
	 ASSOCIAZIONE SPORTIVA DILETTANTISTICA DYNAMIC CENTER GRAVINA, 19CT0745, ITA	1	0	0	1	0	0	0	6
	 KYU SHIN DO KAI PARMA ASSOCIAZIONE SPORTIVA DILETTANTISTICA, 08PR1231, ITA	1	0	0	1	0	0	0	6
	 A.S.DILETTANTISTICA JUDO PRENESTE G. CASTELLO, 12RM0163, ITA	1	0	0	1	0	0	0	6
	 ENERGY MEDIGLIA PALESTRE S.S. DILETTANTISTICA A R.L., 03MI3491, ITA	2	0	0	1	0	0	0	6
21	 A.S.DILETTANTISTICA EQUIPE JUDO CALDOGNO, 05VI3911, ITA	1	0	0	0	1	0	0	4
	 A.S.DILETTANTISTICA BUDOKAN ISTITUTE BOLOGNA, 08BO1292, ITA	1	0	0	0	1	0	0	4
	 A.S.DILETTANTISTICA EQUIPE EMILIA JUDO, 08RE3460, ITA	1	0	0	0	1	0	0	4
	 JUDO CLUB LISSONE ASSOCIAZIONE SPORTIVA DILETTANTISTICA, 03MI0219, ITA	1	0	0	0	1	0	0	4
	 CENTRO SPORTIVO BUDOKAI ASSOCIAZIONE SPORTIVA DILETTANTISTICA, 13AQ0362, ITA	1	0	0	0	1	0	0	4
	 ASSOCIAZIONE SPORTIVA DILETTANTISTICA MEETING JUDO KARATE, 15NA0265, ITA	1	0	0	0	1	0	0	4
	 ASSOCIAZIONE SPORTIVA DILETTANTISTICA JUDO VANZAGO, 03MI3079, ITA	1	0	0	0	1	0	0	4
	*  MALTA JUDO FEDEARTION, , MLT	2	0	0	0	1	0	0	4
29	 ASD E APS JIGORO KANO TORINO, 01TO1222, ITA	1	0	0	0	0	1	0	2

Classifica Società Sportive / XXVII ALPE ADRIA GRAND PRIX JUN/SEN - 2022-10-01



















	 ASSOCIAZIONE SPORTIVA DILETTANTISTICA JUDO FRASCATI, 12RM0360, ITA	1	0	0	0	0	1	0	2
	 ARTI MARZIALI GIAPPONESI JUDO MURANO ASSOCIAZIONE SPORTIVA DILETTANTISTICA, 05VE0101, ITA	1	0	0	0	0	1	0	2
32	 ACCADEMIA ARTI MARZIALI A.S.DILETTANTISTICA, 03BG4194, ITA	1	0	0	0	0	0	0	0
	 ASSOCIAZIONE SPORTIVA DILETTANTISTICA JUDO SAN, 04TN2775, ITA	1	0	0	0	0	0	0	0





















Classifica Società Sportive
XXVII ALPE ADRIA GRAND PRIX JUN/SEN - 2022-10-01

<i>Rank</i>	<i>Club</i>	<i>Athlete</i>	<i>1. Place</i>	<i>2. Place</i>	<i>3. Place</i>	<i>5. Place</i>	<i>7. Place</i>	<i>11. Place</i>	<i>Total</i>
1	ISAO OKANO CLUB 97 ASSOCIAZIONE SPORTIVA DILETTANTISTICA, 03MI1448, ITA	9	1	0	2	2	0	0	30
2	C.R.S. AKIYAMA SOCIETA SPORTIVA DILETTANTISTICA A R.L., 01TO0430, ITA	11	0	1	3	0	1	0	28
3	A.S. DILETTANTISTICA BANZAI CORTINA ROMA, 12RM0162, ITA	4	0	2	1	1	0	0	26
4	A.S.DILETTANTISTICA BUDOKAN ISTITUTE BOLOGNA, 08BO1292, ITA	6	1	0	1	0	0	1	16
5	ASSOCIAZIONE SPORTIVA DILETTANTISTICA NIPPON CLUB, 15NA1418, ITA	5	1	0	0	1	0	0	14
	G.S.FIAMME ORO ROMA, 12RM0061, ITA	3	0	1	1	0	0	0	14
	A.S.DILETTANTISTICA PRO RECCO JUDO, 07GE0173, ITA	5	0	1	0	1	1	0	14
8	A.S.DILETTANTISTICA JUDO TEAM IACOVAZZI, 16BA3642, ITA	2	1	0	0	0	1	0	12
9	CENTRO SPORTIVO ESERCITO ROMA, 12RM0134, ITA	1	1	0	0	0	0	0	10
	ASSOCIAZIONE SPORTIVA DILETTANTISTICA CENTRO SCUOLE JUDO, 12RM2292, ITA	2	1	0	0	0	0	0	10
	KYU SHIN DO KAI PARMA ASSOCIAZIONE SPORTIVA DILETTANTISTICA, 08PR1231, ITA	3	1	0	0	0	0	1	10
	SHIDOKAN 2018 A.S.DILETTANTISTICA, 06PN4102, ITA	3	0	0	1	1	0	0	10



















Classifica Società Sportive / XXVII ALPE ADRIA GRAND PRIX JUN/SEN - 2022-10-01

13	 A.S.DILETTANTISTICA POLISP. GIGLIOTTI TEAM NUORO, 20NU3244, ITA	1	0	1	0	0	0	0	8
	 ASSOCIAZIONE SPORTIVA DILETTANTISTICA JUDO TREVISO, 05TV0076, ITA	2	0	1	0	0	0	0	8
15	 S.S.O.L. MOLDOVA, , MDA	1	0	0	1	0	0	0	6
	 HARMONY CLUB A.S.DILETTANTISTICA, 12RM4079, ITA	2	0	0	1	0	0	0	6
	 ENERGY MEDIGLIA PALESTRE S.S. DILETTANTISTICA A R.L., 03MI3491, ITA	2	0	0	1	0	0	0	6
	 A.S.DILETTANTISTICA JUDO KODOKAN EMPOLI, 09FI0231, ITA	3	0	0	1	0	0	0	6
	 A.S.DILETTANTISTICA GIROLAMO GIOVINAZZO, 12RM3376, ITA	2	0	0	0	1	1	0	6
	 A.S. DILETTANTISTICA GUGLIELMI, 16BT0409, ITA	1	0	0	0	0	0	0	6
21	 C.U.S. SIENA ASSOCIAZIONE SPORTIVA DILETTANTISTICA, 09SI0257, ITA	1	0	0	0	1	0	0	4
	 A.S.DILETTANTISTICA NEW CRAZY FITNESS, 15CE4029, ITA	1	0	0	0	1	0	0	4
	 ASSOCIAZIONE SPORTIVA DILETTANTISTICA SPORTS TEAM, 05TV0735, ITA	1	0	0	0	1	0	0	4
	 ASSOCIAZIONE SPORTIVA DILETTANTISTICA DOJO SACILE, 06PN1518, ITA	1	0	0	0	1	0	0	4
	 A.S.DILETTANTISTICA KODOKAN RHO, 03MI3974, ITA	1	0	0	0	1	0	0	4
	 A.S.DILETTANTISTICA JUDO CLUB PERGINE, 04TN1017, ITA	2	0	0	0	1	0	1	4
	 A.S.DILETTANTISTICA JUDO PASSE-PARTOUT TERNI, 10TR1610, ITA	2	0	0	0	0	2	0	4
	 JUDO CLUB CAMERANO ASSOCIAZIONE SPORTIVA DILETTANTISTICA, 11AN0160, ITA	2	0	0	0	0	2	0	4
29	 A.S.DILETTANTISTICA JUDO KODOKAN S.ANGELO, 09FI0819, ITA	1	0	0	0	0	1	0	2
	 ASSOCIAZIONE SPORTIVA DILETTANTISTICA JUDO CARUGATE, 03MI1974, ITA	1	0	0	0	0	1	0	2
	 ASSOCIAZIONE SPORTIVA DILETTANTISTICA JUDOKWAI MESTRE, 05VE0281, ITA	3	0	0	0	0	1	0	2



Classifica Società Sportive / XXVII ALPE ADRIA GRAND PRIX JUN/SEN - 2022-10-01

	 KUMIAI S.S. DILETTANTISTICA A R.L., 01TO3089, ITA	3	0	0	0	0	1	0	2
33	 A&R PALESTRE S.S.DILETTANTISTICA A R.L., 06TS3610, ITA	1	0	0	0	0	0	0	0
	 A.S.DILETTANTISTICA EQUIPE JUDO CALDOGNO, 05VI3911, ITA	1	0	0	0	0	0	0	0
	 JUDO CLUB KURIHARA ASSOCIAZIONE SPORTIVA DILETTANTISTICA, 03MI0184, ITA	1	0	0	0	0	0	0	0
	 ASSOCIAZIONE SPORTIVA DILETTANTISTICA JUDO CLUB SEGRATE, 03MI0728, ITA	1	0	0	0	0	0	0	0
	 ASSOCIAZIONE SPORTIVA DILETTANTISTICA SKORPION CLUB LIBERTAS PORDENONE, 06PN0282, ITA	1	0	0	0	0	0	0	0
	 A.S.DILETTANTISTICA KODOKAN LUCANIA BRIENZA, 17PZ1743, ITA	1	0	0	0	0	0	0	0
	 LA PALESTRA ASSOCIAZIONE SPORTIVA DILETTANTISTICA, 16TA2640, ITA	1	0	0	0	0	0	0	0
	 JUDO CLUB KEN OTANI-MELEGNANO A.S. DILETTANTISTICA, 03MI2133, ITA	1	0	0	0	0	0	0	0
	 A.S.D. JUDO AZZURRO, , ITA	1	0	0	0	0	0	0	0
	 ASSOCIAZIONE SPORTIVA DILETTANTISTICA JUDO VALPOLICELLA, 05VR1810, ITA	1	0	0	0	0	0	0	0
	 A.S.D. DOJO EQUIPE BOLOGNA, 08BO1093, ITA	1	0	0	0	0	0	0	0
	 ASSOCIAZIONE SPORTIVA DILETTANTISTICA JUDO VANZAGO, 03MI3079, ITA	1	0	0	0	0	0	0	0
	*  MALTA JUDO FEDEARTION, , MLT	1	0	0	0	0	0	0	0
	 A.S. DILETTANTISTICA JUDO KODOKAN MASERADA SUL PIAVE, 05TV1133, ITA	1	0	0	0	0	0	0	0
	 A.S.D. JUDOKAN, 12RM3409, ITA	1	0	0	0	0	0	0	0
	 ASSOCIAZIONE SPORTIVA DILETTANTISTICA JIGORO KANO JUDO CAPIAGO, 03CO2449, ITA	1	0	0	0	0	0	0	0
	 A.S.DILETTANTISTICA GINNASTICA PAULLESE, 03MI3230, ITA	1	0	0	0	0	0	0	0
	 ACQUAFRESCA SPORT CENTER A.S.DILETTANTISTICA, 05VR3937, ITA	1	0	0	0	0	0	0	0
	 A.S.DILETTANTISTICA EQUIPE EMILIA JUDO, 08RE3460, ITA	1	0	0	0	0	0	0	0

Classifica Società Sportive / XXVII ALPE ADRIA GRAND PRIX JUN/SEN - 2022-10-01

 C.U.S. FERRARA ASSOCIAZIONE SPORTIVA DILETTANTISTICA, 08FE3078, ITA	1	0	0	0	0	0	0	0
 JUDO CLUB PARABIAGO DILETTANTISTICA, 03MI1744, ITA	1	0	0	0	0	0	0	0
 CENTRO SPORTIVO GIOVANILE - ASSOCIAZIONE SPORTIVA DILETTANTISTICA, 03MI0660, ITA	1	0	0	0	0	0	0	0
 A.S.D. KODOKAN JUDO BERGAMO, 03BG0986, ITA	1	0	0	0	0	0	0	0
 ASSOCIAZIONE SPORTIVA DILETTANTISTICA JUDO CLUB SAN VITO, 06PN0521, ITA	1	0	0	0	0	0	1	0
 ASSOCIAZIONE SPORTIVA DILETTANTISTICA JUDO BERGAMO, 03BG1886, ITA	2	0	0	0	0	0	0	0
 ASSOCIAZIONE SPORTIVA DILETTANTISTICA JUDO AZZANESE, 06PN0354, ITA	2	0	0	0	0	0	0	0
 ASSOCIAZIONE SPORTIVA DILETTANTISTICA JUDO CLUB ROZZANO, 03MI0392, ITA	2	0	0	0	0	0	0	0
 JUDO CLUB SAKURA OSIMO ASSOCIAZIONE SPORTIVA DILETTANTISTICA, 11AN0063, ITA	2	0	0	0	0	0	0	0
 A.S. DILETTANTISTICA STAR JUDO CLUB, 15NA1406, ITA	2	0	0	0	0	0	0	0
 A.S. DILETTANTISTICA KYU SHIN RYU PRATO, 09PO1285, ITA	2	0	0	0	0	0	0	0
 A.S.D. CENTER PARMA, 08PR1187, ITA	2	0	0	0	0	0	0	0
 EISHO CLUB MILANO SDD SRL, 03MI4403, ITA	2	0	0	0	0	0	0	0
 ASSOCIAZIONE SPORTIVA DILETTANTISTICA JUDO FRASCATI, 12RM0360, ITA	2	0	0	0	0	0	1	0
 A.S.DILETTANTISTICA JUDO VITTORIO VENETO, 05TV0734, ITA	2	0	0	0	0	0	0	0
 ASSOCIAZIONE DILETTANTISTICA SPORTIVA CENTRO SPORTIVO OLBIA, 20SS1532, ITA	3	0	0	0	0	0	0	0
 ASSOCIAZIONE SPORTIVA DILETTANTISTICA SHENTAO SCUOLA ARTI MARZIALI, 03BG2268, ITA	3	0	0	0	0	0	0	0
 ARTI MARZIALI GIAPPONESI JUDO MURANO ASSOCIAZIONE SPORTIVA DILETTANTISTICA, 05VE0101, ITA	3	0	0	0	0	0	0	0

Classifica Società Sportive / XXVII ALPE ADRIA GRAND PRIX JUN/SEN - 2022-10-01

 ASSOCIAZIONE SPORTIVA DILETTANTISTICA JIGORO KANO JUDO CLUB VICENZA, 05VI0079, ITA	4	0	0	0	0	0	0	0
 ASSOCIAZIONE SPORTIVA DILETTANTISTICA JUDO KUROKI, 06UD0623, ITA	6	0	0	0	0	0	0	0