



Porec Millennium Team Cadet European Cup 2025

Croatia, Porec, 15-16 Mar 2025

-73 kg
Cadets (77)

POOL A

SRB	MILJIC Sinisa	1	MILJIC S. (SRB)
CRO	PAVLOVIC Fredi	2	PAVLOVIC F. (CRO)
ESP	IKEME MASCARO Sergi	3	IKEME MASCARO S. (ESP)
GBR	ABASHIDZE Luka	4	ABASHIDZE L. (GBR)
UKR	VOROBEL Vitalii	5	BRUZHANITSKY T. (ISR)
ISR	BRUZHANITSKY Tal	6	BRUZHANITSKY T. (ISR)
SLO	KROTKO Til	7	KROTKO T. (SLO)
GER	POHLMANN Willi-Balduin	8	POHLMANN W. (GER)
CRO	MASATOVIC Marin	9	MASATOVIC M. (CRO)
FRA	HAMDAOUI Ahmed-Adam	10	HAMDAOUI A. (FRA)
HUN	TERJEK Temes	11	TERJEK T. (HUN)
SRB	ANKIC Andrej	12	SHERIPADZE D. (GEO)
GEO	SHERIPADZE Dachi	13	SHERIPADZE D. (GEO)
SVK	LAZAR Milan	14	LAZAR M. (SVK)
UKR	NAIDIUK Volodymyr	15	NAIDIUK V. (UKR)
CRO	HREN Adrian	16	HREN A. (CRO)
BIH	GVOZDENAC Vuk	17	GVOZDENAC V. (BIH)
SLO	FRELON Dan	18	DIRR J. (AUT)
AUT	DIRR Joe	19	DIRR J. (AUT)

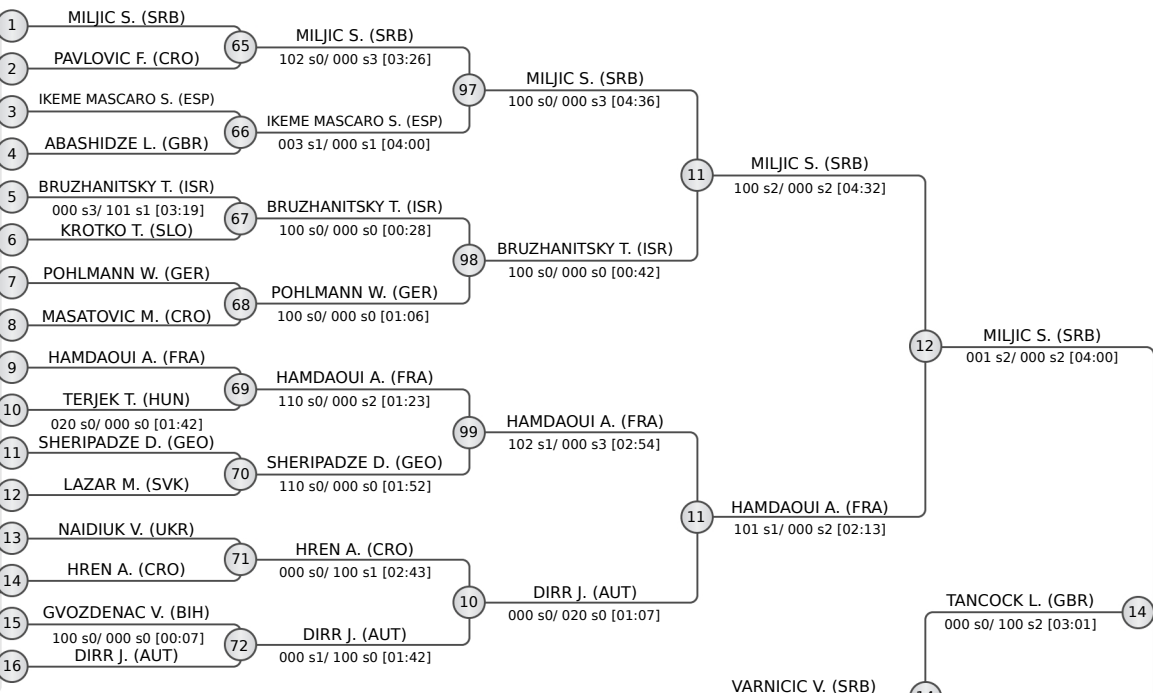

POOL B

CAN	LE BRIS Lowan	20	LE BRIS L. (CAN)
UKR	PIVNIUK Artem	21	PIVNIUK A. (UKR)
CRO	KRMEK Roko Ivan	22	POGGI M. (ITA)
ITA	POGGI Matteo	23	TANCOCK L. (GBR)
GBR	TANCOCK Lenny	24	TANCOCK L. (GBR)
AUT	VRABETZ Alexander	25	VRABETZ A. (AUT)
SLO	STEVANOVIC GORJUP Erik	26	VRABETZ A. (AUT)
CRO	MEDIC Vid	27	JALIC U. (SRB)
SRB	JALIC Uros	28	JALIC U. (SRB)
SMR	DE ANGELIS Luca	29	DE ANGELIS L. (SMR)
POL	BORZECKI Jakub	30	BORZECKI J. (POL)
GEO	MACHURIDZE Vladimer	31	MACHURIDZE V. (GEO)
SLO	ADROVIC Leon	32	ADROVIC L. (SLO)
SUI	BRIGGER Ian	33	BRIGGER I. (SUI)
HUN	GOMBKOTO Misa	34	TANASJEVIC A. (SRB)
SRB	TANASJEVIC Aleksa	35	TANASJEVIC A. (SRB)
CRO	GAURINA Josip	36	GAURINA J. (CRO)
BIH	MARIJANOVIC Mihajlo	37	MARIJANOVIC M. (BIH)
ISR	BEN LAICHE Edo	38	BEN LAICHE E. (ISR)

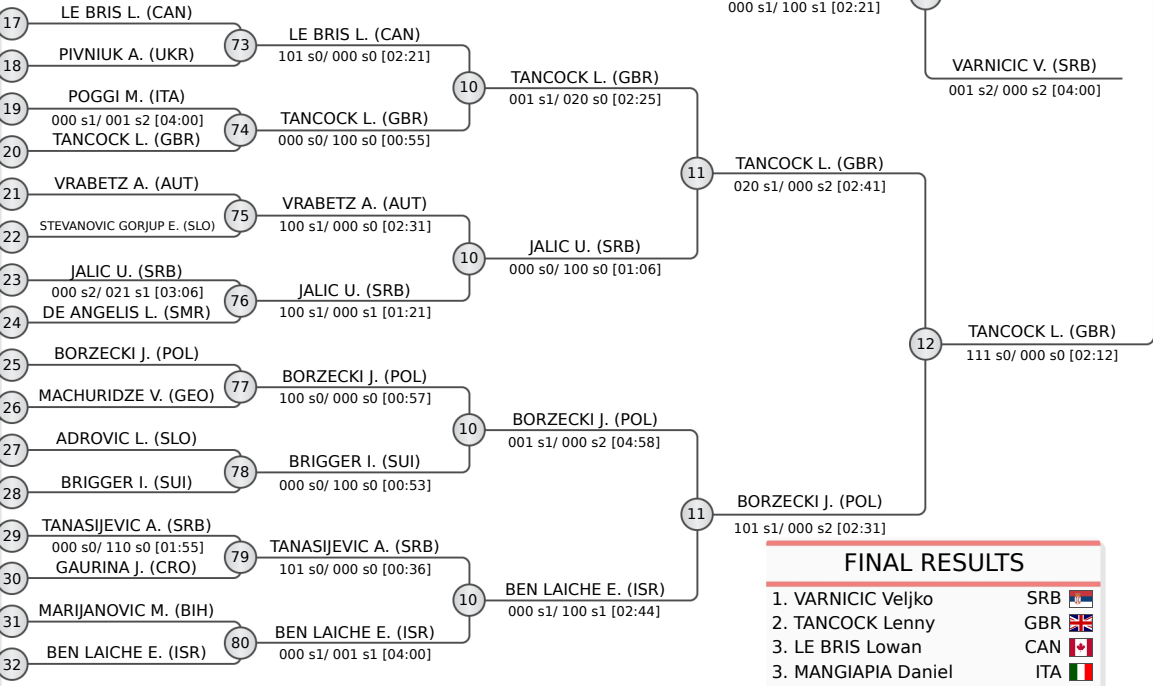

FINAL RESULTS		
1.	VARNICIC Veljko	SRB
2.	TANCOCK Lenny	GBR
3.	LE BRIS Lowan	CAN
3.	MANGIAPIA Daniel	ITA
5.	HAVRANEK Josip	CRO
5.	MILJIC Sinisa	SRB
7.	IKEME MASCARO Sergi	ESP
7.	NANAVA Luka	GEO

REPECHAGE

12	PAVLOVIC F. (CRO)
12	POGGI M. (ITA)
12	KABRAN K. (FRA)
12	KHARCHENKO M. (UKR)

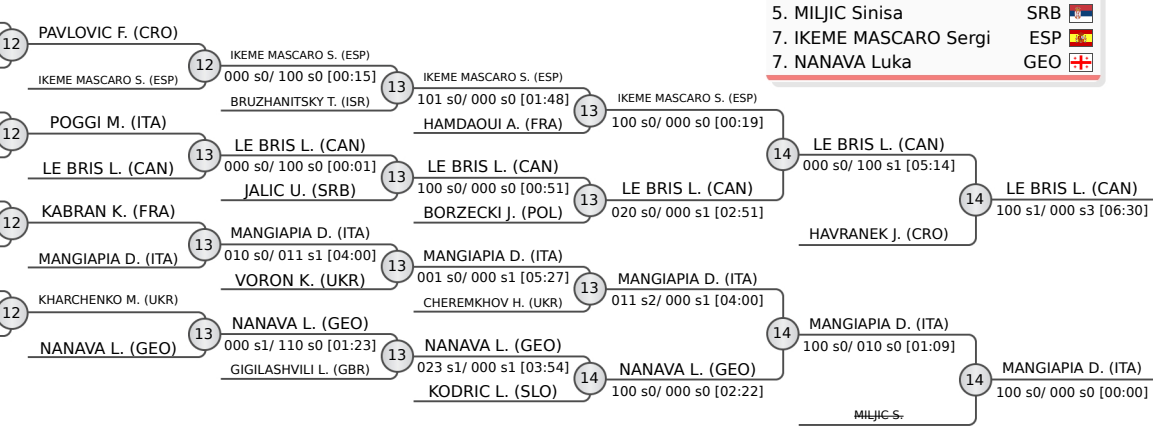



Porec Millennium Team Cadet European Cup 2025

Croatia, Porec, 15-16 Mar 2025

-73 kg

Cadets (77)

POOL C

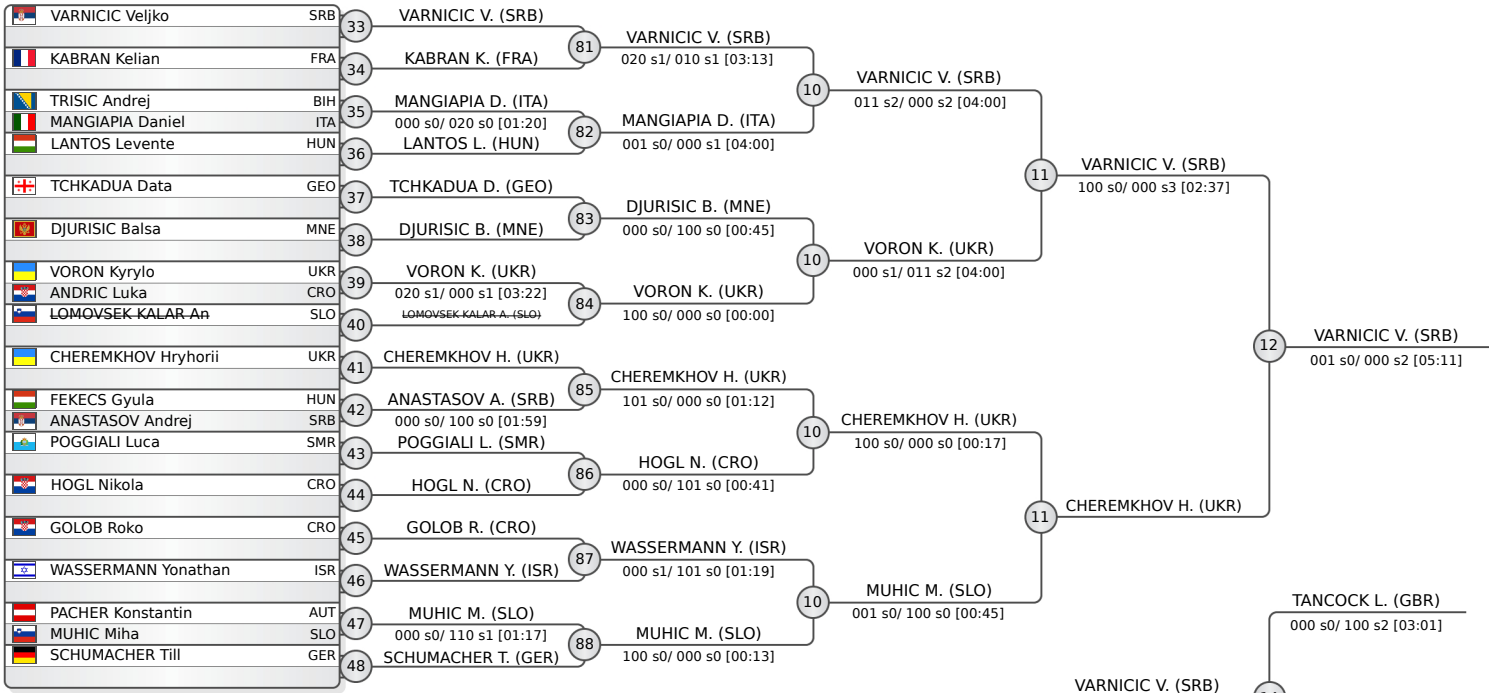

POOL D

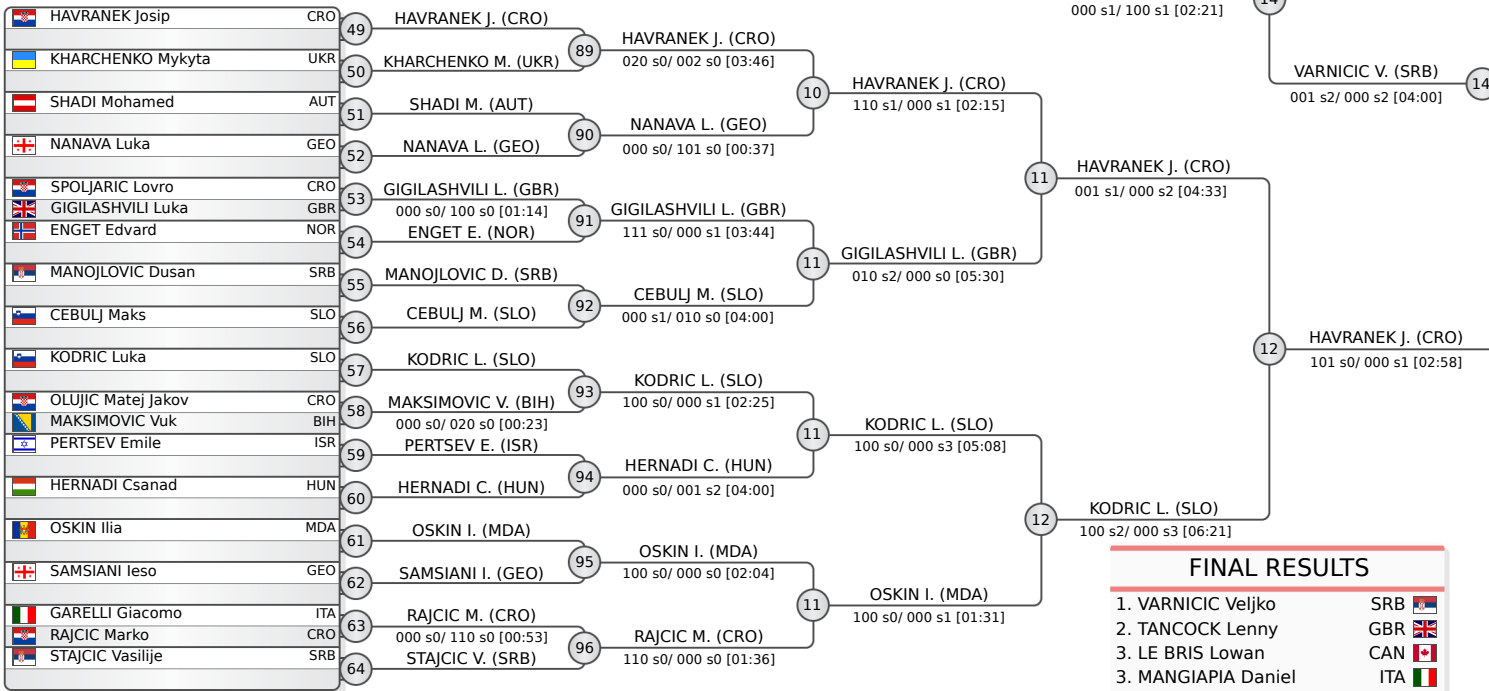

FINAL RESULTS	
1. VARNICIC Veljko	SRB 🇷🇸
2. TANCOCK Lenny	GBR 🇬🇧
3. LE BRIS Lowan	CAN 🇨🇦
3. MANGIAPIA Daniel	ITA 🇮🇹
5. HAVRANEK Josip	CRO 🇭🇷
5. MILJIC Sinisa	SRB 🇷🇸
7. IKEME MASCARO Sergi	ESP 🇪🇸
7. NANAVA Luka	GEO 🇬🇪

REPECHAGE

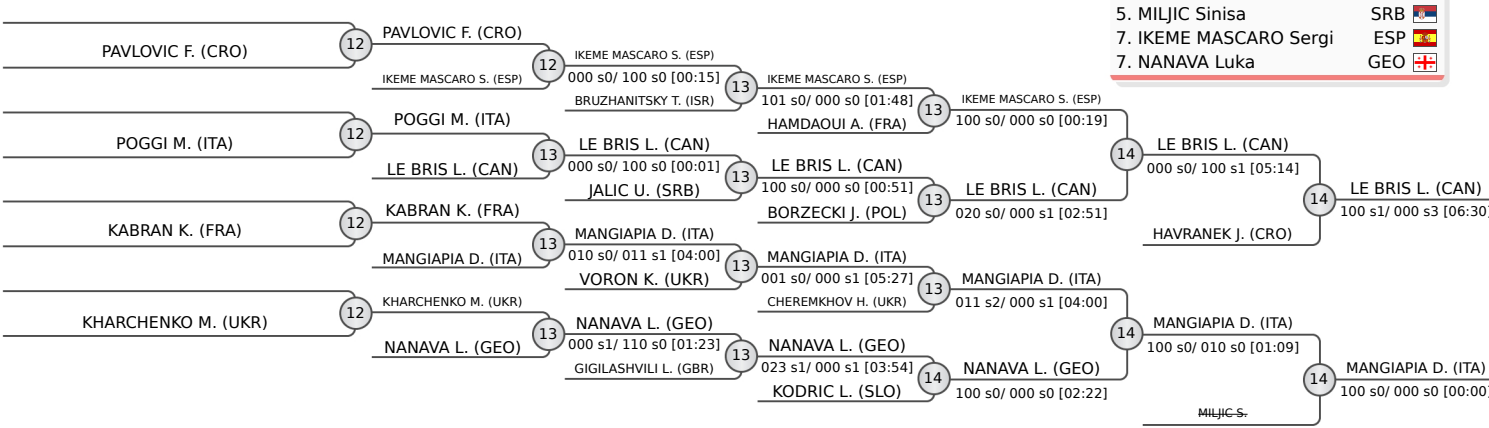



Porec Millennium Team Cadet European Cup 2025

Croatia, Porec, 15-16 Mar 2025

-81 kg

Cadets (64)

POOL A

1	BABAICENKO Tajus (LTU)	1	BABAICENKO T. (LTU)	33	BABAICENKO T. (LTU)
2	SINCHUK Vladyslav (UKR)	2	JALSOVEC N. (CRO)	34	MAN D. (ROU)
3	ARBULLA Alessandro (ITA)	3	MAN D. (ROU)	35	BUZIASHVILI L. (GEO)
4	JALSOVEC Nikola (CRO)	4	TULIK O. (HUN)	36	ASHKENAZI T. (ISR)
5	PERRIN Leandre (FRA)	5	KOVSE Marko (SLO)		
6	MAN Darius (ROU)	6	BUZIASHVILI L. (GEO)		
7	VAVPOTIC Anze (SLO)	7	MARGREITER S. (AUT)		
8	TULIK Oliver (HUN)	8	ASHKENAZI T. (ISR)		
	KOVSE Marko (SLO)				
	BOROJEVIC Veljko (SRB)				
	ROSSI Leonardo (ITA)				
	BUZIASHVILI Luka (GEO)				
	MARGREITER Simon (AUT)				
	KATSARSKI Teodor (BUL)				
	ASHKENAZI Tal (ISR)				
	HAFIZOVIC Edvin (CRO)				

POOL B

9	KRIVEC Aleks (SLO)	9	KRIVEC A. (SLO)	37	KRIVEC A. (SLO)
10	ANTUNOVIC Teo (CRO)	10	SHNIDERMAN L. (ISR)	38	STREICHER K. (FRA)
11	SHNIDERMAN Liroy (ISR)	11	STREICHER K. (FRA)	39	BETKOWSKI J. (POL)
12	BIELSA GONZALEZ Izan (ESP)	12	RAKOCEVIC N. (SRB)	40	MUSELIANI S. (GEO)
13	STREICHER Kellian (FRA)	13	BETKOWSKI J. (POL)		
14	CANEPARI Riccardo (ITA)	14	BEYELER G. (SUI)		
15	KORPAR LEMAC Stribor (CRO)	15	MUSELIANI S. (GEO)		
16	RAKOCEVIC Nikola (SRB)	16	VULIN V. (BIH)		
	BETKOWSKI Jeremiasz (POL)				
	KOVACEVIC Boromir (CRO)				
	SIGNORINI Nicolo (ITA)				
	BEYELER Gabriel (SUI)				
	MUSELIANI Shota (GEO)				
	GRAJFONER Niko (SLO)				
	UNTERRAINER-RAUTTER Jakob (AUT)				
	VULIN Vujadin (BIH)				

POOL C

17	KELLY Akos (AUS)	17	KELLY A. (AUS)	41	WOERMANSEDER K. (AUT)
18	DAVIDASHVILI Yakov (ISR)	18	WOERMANSEDER K. (AUT)	42	BONGAMBE E. (FRA)
19	SIPUSIC Jan (CRO)	19	SVETEC S. (SLO)	43	SEMANJAKU E. (ITA)
20	WOERMANSEDER Klaus (AUT)	20	FREIRE GONZALEZ Nicolas (ESP)	44	SAMSIANI S. (GEO)
21	SVETEC Stas (SLO)	21	VIDAKOVIC Vuk (SRB)		
22	FREIRE GONZALEZ Nicolas (ESP)	22	BONGAMBE Evan (FRA)		
23	VIDAKOVIC Vuk (SRB)	23	SEMANJAKU Erik (ITA)		
24	BONGAMBE Evan (FRA)	24	MARACHEV Pylyp (UKR)		
	SEMANJAKU Erik (ITA)		SINJER Nichita (MDA)		
	MARACHEV Pylyp (UKR)		MATKOVIC Ante (CRO)		
	SINJER Nichita (MDA)		MARTINEZ KOVAC Jan Estefano (SLO)		
	MATKOVIC Ante (CRO)		ANDERKO Bence (HUN)		
	MARTINEZ KOVAC Jan Estefano (SLO)		SAMSIANI Saba (GEO)		
	ANDERKO Bence (HUN)		DJEKOVIC Vasilije (SRB)		
	SAMSIANI Saba (GEO)				
	DJEKOVIC Vasilije (SRB)				

POOL D

25	OBRADOVIC Nikola (SRB)	25	OBRADOVIC N. (SRB)	45	OBRADOVIC N. (SRB)
26	BERIANIDZE Rati (GEO)	26	MEIER G. (LIE)	46	SVALINA N. (CRO)
27	MEIER Gabriel (LIE)	27	VASIC Vladislav (SLO)	47	RUSSO E. (ITA)
28	VASIC Vladislav (SLO)	28	SVALINA Nikola (CRO)	48	SAKHAROV N. (UKR)
29	SVALINA Nikola (CRO)	29	ZUCCHERI Leonardo (ITA)		
30	ZUCCHERI Leonardo (ITA)	30	LECHOWICZ Marek (POL)		
31	LECHOWICZ Marek (POL)	31	SCHEIBER Felix (AUT)		
32	SCHEIBER Felix (AUT)	32	RUSSO Edoardo Michele (ITA)		
	RUSSO Edoardo Michele (ITA)		KRZELJ Dante (CRO)		
	KRZELJ Dante (CRO)		PERECZ Mark (HUN)		
	PERECZ Mark (HUN)		BERGLEZ KOS Val (SLO)		
	BERGLEZ KOS Val (SLO)		SHENGELIA Nikoloz (GBR)		
	SHENGELIA Nikoloz (GBR)		SOSO Marko (CRO)		
	SOSO Marko (CRO)		SAKHAROV Nikita (UKR)		
	SAKHAROV Nikita (UKR)		FILIP Andrei (FRA)		
	FILIP Andrei (FRA)				

REPECHAGE

61	SINCHUK V. (UKR)	61	SINCHUK V. (UKR)	65	SINCHUK V. (UKR)
62	JALSOVEC N. (CRO)	62	MAN D. (ROU)	66	SHNIDERMAN L. (ISR)
63	ANTUNOVIC T. (CRO)	63	SHNIDERMAN L. (ISR)	67	SEMANJAKU E. (ITA)
64	SHNIDERMAN L. (ISR)	64	STREICHER K. (FRA)	68	RUSSO E. (ITA)
	DJEKOVIC V. (SRB)		MARTINEZ KOVAC J. (SLO)		
	MARTINEZ KOVAC J. (SLO)				
	FILIP A. (FRA)				
	SHENGELIA N. (GBR)				

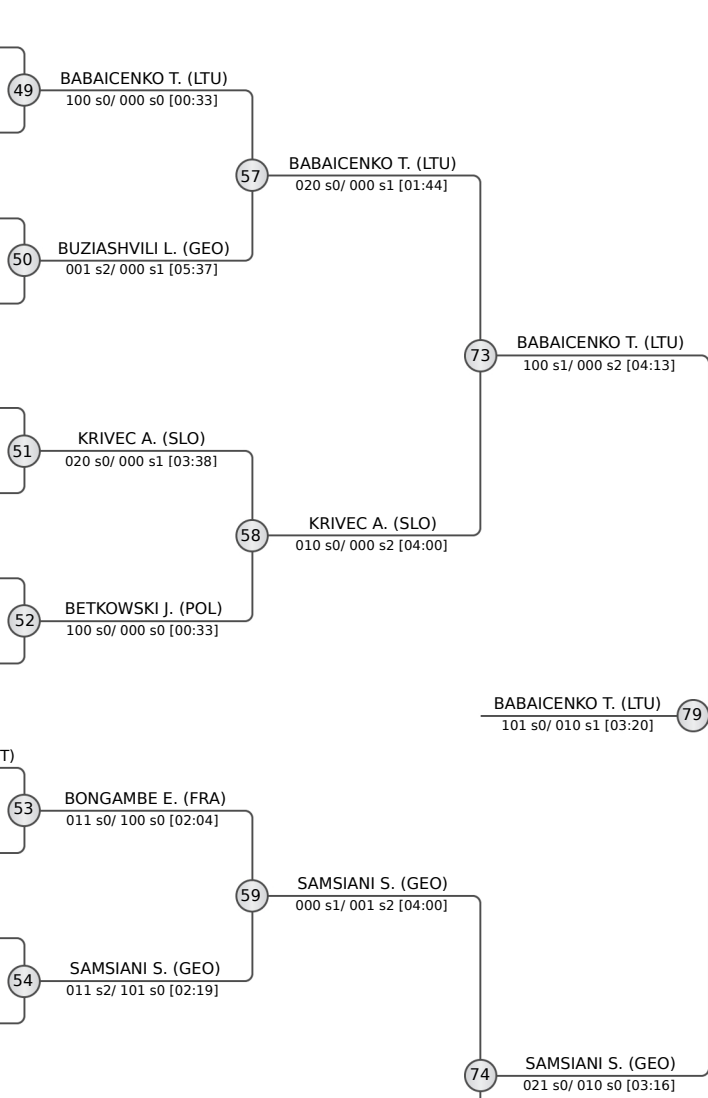

FINAL RESULTS	
1.	BABAICENKO Tajus (LTU)
2.	SAMSIANI Saba (GEO)
3.	SAKHAROV Nikita (UKR)
5.	BETKOWSKI Jeremiasz (POL)
5.	OBRADOVIC Nikola (SRB)
7.	SINCHUK Vladyslav (UKR)
7.	BONGAMBE Evan (FRA)



Porec Millennium Team Cadet European Cup 2025

Croatia, Porec, 15-16 Mar 2025

-90 kg

Cadets (41)

POOL A

	SIMIC Nemanja	SRB	1
	RADULOVIC Jovan	MNE	2
	FERNANDEZ CALERO Pablo	ESP	3
	VUJICIC Dusan	BIH	3
	MILKOVIC Bojan	CRO	4
	VUJICA Marko	CRO	5
	SVATEK Jozef	SVK	6
	MORONI Leonardo	ITA	7
	SIKHASHVILI Saba	GEO	8
	NEACSU Rares	ROU	8

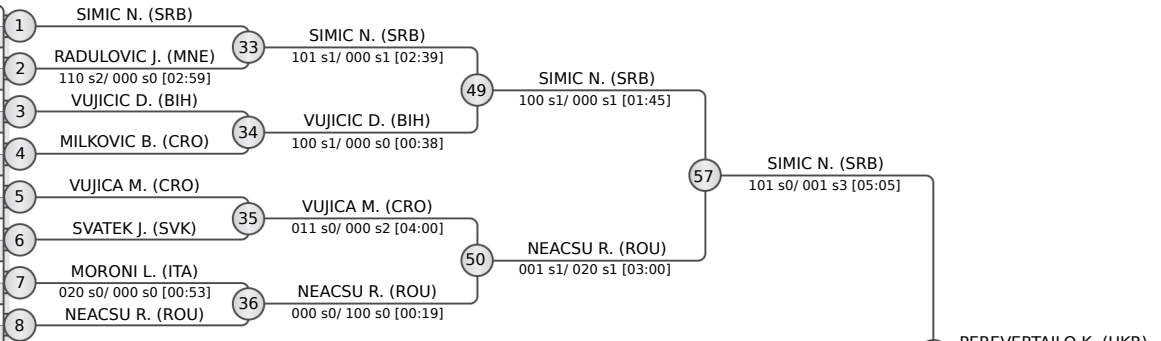

POOL B

	SUNDBY Marius	NOR	9
	MARX Gregor	AUT	10
	SKOPAC Jakov	CRO	11
	JOVIC Dragan	SRB	11
	MARINO Fabrizio	ITA	12
	FRANCA Aljaz	SLO	13
	TOTH Zsombor	HUN	14
	SIKULJAK Relja	BIH	14
	BOYUNGA BOKULUTA Elie	UKR	15
	PEREVERTAILO Kyrylo	UKR	15
	OHAYON Noam	ISR	16

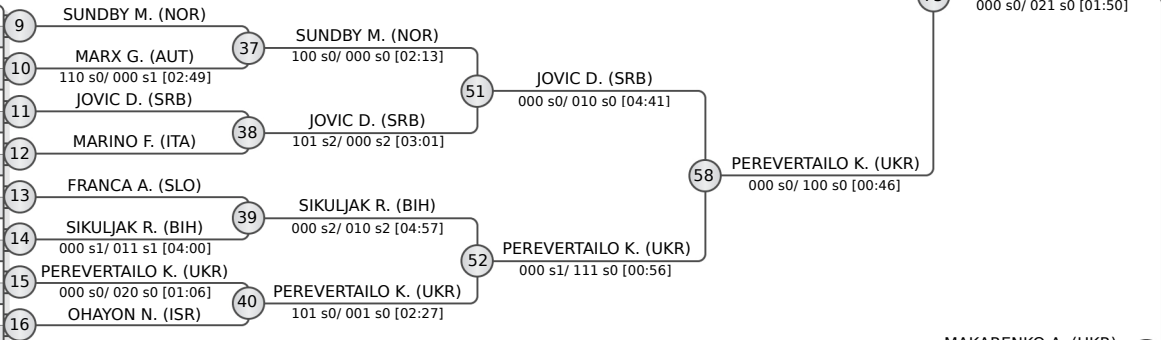

POOL C

	QUINTEROS Tomas	ARG	17
	MULTON KANDU MPALA Cedric	FRA	18
	SIUKASHVILI Sandro	GEO	19
	STANEV Zdravko	BUL	19
	MAKARENKO Artur	UKR	20
	HORNGACHER Lorenz	AUT	21
	MAIANO Alessio	ITA	22
	SALAMON Barnabas	HUN	23
	JERKUNICA Anton	CRO	24
	POPOVIC Petar	BIH	24

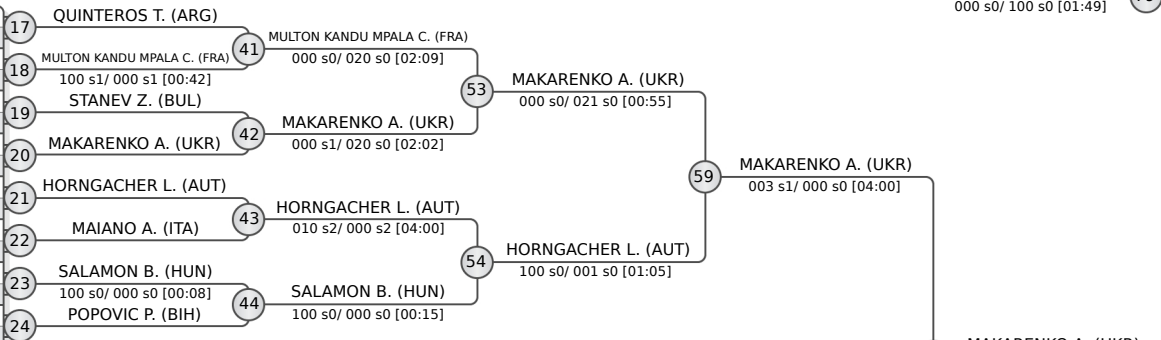

POOL D

	MAZZON Francesco	ITA	25
	VALENTIN Jeremy	LUX	26
	RUDIC Luka	CRO	26
	KOPRIVICA Jovan	SRB	27
	KOGUASHVILI Giorgi	GEO	28
	CAPEZZUTO Antonio	ITA	29
	POPOVIC Andrija	MNE	30
	SEGUIN RENDAL Ian	ESP	31
	VOJINOVIC Lazar	BIH	31
	HECKO Daniel	SVK	32

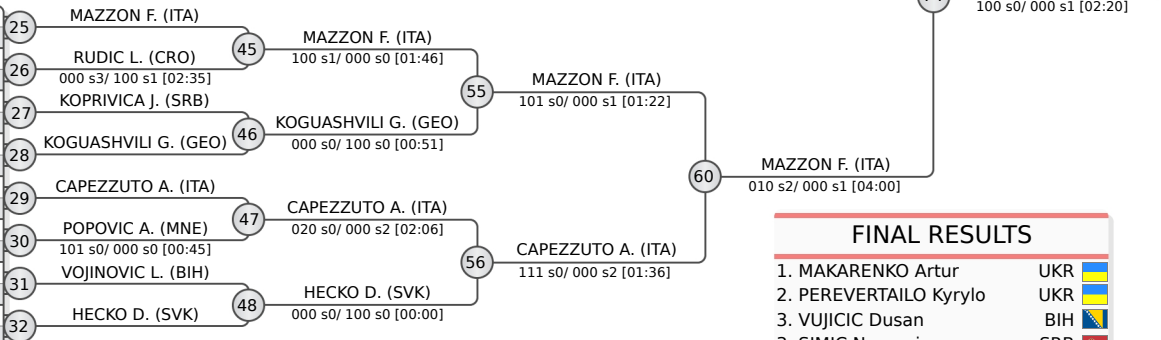

FINAL RESULTS		
1.	MAKARENKO Artur	UKR
2.	PEREVERTAILO Kyrylo	UKR
3.	VUJICIC Dusan	BIH
3.	SIMIC Nemanja	SRB
5.	MAZZON Francesco	ITA
5.	HORNGACHER Lorenz	AUT
7.	JOVIC Dragan	SRB
7.	CAPEZZUTO Antonio	ITA

REPECHAGE

	RADULOVIC J.	(MNE)	61
	BOYUNGA BOKULUTA E.	(FRA)	62
	OHAYON N.	(ISR)	62
	STANEV Z.	(BUL)	63
	RUDIC L.	(CRO)	64

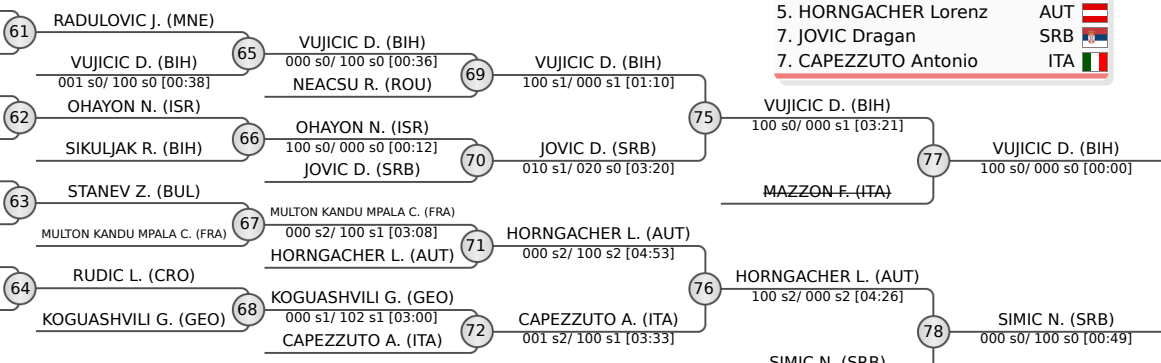



Porec Millennium Team Cadet European Cup 2025

Croatia, Porec, 15-16 Mar 2025

+ 90 kg

Cadets (26)

POOL A

	NOVAKOVIC Petar	SRB
	HUBKO Yehor	UKR
	IVOSIC Vito	CRO
	CORSICA Michele	ITA
	PLESCA Catalin	MDA
	KASHIBADZE Giorgi	GEO
	ZAMAI Zakhar	UKR

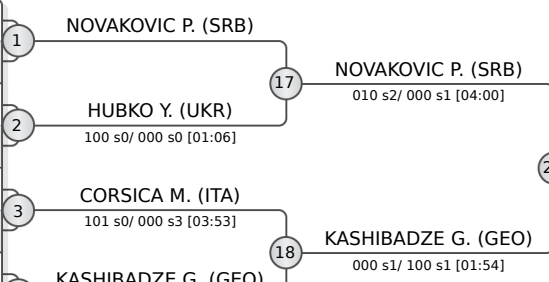

POOL B

	PICCHI Gianluca	ITA
	TITAN Ohad	ISR
	APTSIAURI Nikoloz	GEO
	CSERMAK Daniel	HUN
	MRSIC Roko	CRO
	NAZARCHUK Daniil	UKR

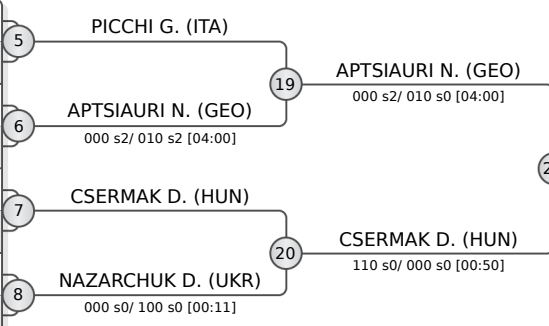

POOL C

	LUBURA Nikola	BIH
	TIUKH Yurii	UKR
	ZAKUTASHVILI Ilia	GEO
	ANGERER Lukas	AUT
	FRANGEZ Gal	SLO
	MIKOLA Niko	CRO
	FALUSI Zsolt	HUN

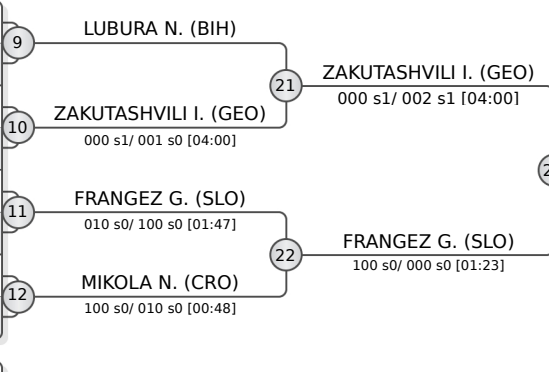

POOL D

	SZEKERES Abel	HUN
	BISCHOFF Samuel	GER
	ZHADAN Serhii	UKR
	DAVRASHELIDZE Hamlet	GEO
	MARIC Luka	SRB
	CVITKOVIC Ivan	CRO

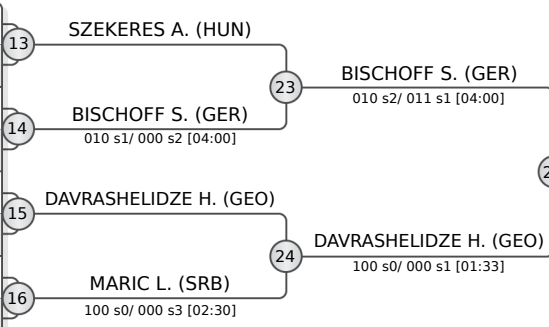

REPECHAGE

ZAMAI Z. (UKR)	CORSICA M. (ITA)	29
CORSICA M. (ITA)	NOVAKOVIC P. (SRB)	33
NAZARCHUK D. (UKR)	APTSIAURI N. (GEO)	30
TIUKH Y. (UKR)	LUBURA N. (BIH)	31
LUBURA N. (BIH)	FRANGEZ G. (SLO)	35
MARIC L. (SRB)	MARIC L. (SRB)	32
MARIC L. (SRB)	BISCHOFF S. (GER)	36

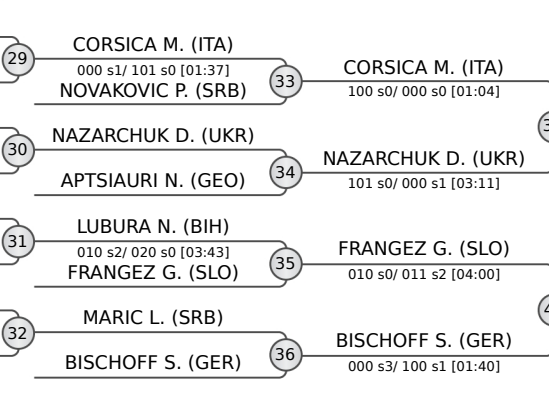

FINAL RESULTS

1. CSERMAK Daniel HUN
2. ZAKUTASHVILI Ilia GEO
3. CORSICA Michele ITA
3. BISCHOFF Samuel GER
5. DAVRASHLIDZE Hamlet GEO
5. KASHIBADZE Giorgi GEO
7. NAZARCHUK Daniil UKR
7. FRANGEZ Gal SLO



Porec Millennium Team Cadet European Cup 2025

Croatia, Porec, 15-16 Mar 2025

-57 kg
Cadets (66)

POOL A

1	VEINHANDL OBAID Haya (SLO)	1	VEINHANDL OBAID H. (SLO)
2	GIORDANO Valeria (ITA)	65	VEINHANDL OBAID H. (SLO) 100 s1/ 000 s3 [04:15]
3	PALLAI Dora (HUN)	3	PALLAI D. (HUN)
4	ARIDON Ornella (FRA)	66	ARIDON O. (FRA) 000 s3/ 100 s1 [04:38]
5	ZIVKOVIC Tamara (SRB)	5	ZIVKOVIC T. (SRB)
6	RUSINOVA Yuliana (BUL)	67	VAZQUEZ FERNANDEZ I. (ESP) 001 s2/ 000 s1 [04:00]
7	VAZQUEZ FERNANDEZ Irene (ESP)	6	VAZQUEZ FERNANDEZ I. (ESP) 000 s2/ 001 s1 [05:01]
8	TOMESCU Yasmine (ROU)	7	TOMESCU Y. (ROU)
9	BARAC Patricija (CRO)	8	BARAC P. (CRO) 100 s0/ 000 s0 [00:22]
10	BOZSO Zita (HUN)	9	BOZSO Z. (HUN)
11	SHATTOCK Maisie (GBR)	10	SHATTOCK M. (GBR) 021 s1/ 000 s1 [02:54]
12	RUCHTI Noemi (SUI)	11	RUCHTI N. (SUI)
13	RACIC Ana Marija (CRO)	12	RACIC A. (CRO) 100 s0/ 000 s0 [01:14]
14	KYIALBEKOVA Aaisha (KGZ)	13	KYIALBEKOVA A. (KGZ)
15	POTOCKI Dora (CRO)	14	POTOCKI D. (CRO) 100 s0/ 000 s2 [00:56]
16	MEKAITON Shira (ISR)	15	MEKAITON S. (ISR)
17	MIKOTA Katharina (AUT)	16	MIKOTA K. (AUT) 000 s1/ 101 s2 [03:42]

POOL B

17	BARTYIK Iza (HUN)	17	BARTYIK I. (HUN)
18	TRAAVIK Asal (NOR)	18	TRAAVIK A. (NOR) 000 s0/ 100 s0 [02:16]
19	VALIYEVA Nazakat (AZE)	19	VALIYEVA N. (AZE)
20	BALABAN Sofia (UKR)	20	BALABAN S. (UKR) 010 s0/ 000 s0 [04:00]
21	ROITBERG Emma (ITA)	21	ROITBERG E. (ITA)
22	VIDAK Matea (CRO)	22	VIDAK M. (CRO) 100 s0/ 001 s0 [00:33]
23	GIMENO PEREIRA Julia (ESP)	23	GIMENO PEREIRA J. (ESP)
24	BAUER Susanne (AUT)	24	BAUER S. (AUT) 110 s2/ 000 s2 [02:06]
25	MORUZZI Rachele (ITA)	25	MORUZZI R. (ITA)
26	GUZINA Vanja (MNE)	26	GUZINA V. (MNE) 102 s0/ 000 s0 [03:25]
27	BIKIC Karmen (CRO)	27	BIKIC K. (CRO)
28	NEAGU Isabela Ioana (ROU)	28	NEAGU I. (ROU) 000 s0/ 110 s0 [00:42]
29	CLARK Isabelle (SUI)	29	CLARK I. (SUI)
30	DJOKIC Elena (SRB)	30	DJOKIC E. (SRB) 100 s0/ 000 s0 [00:18]
31	MASTNAK Zarja (SLO)	31	MASTNAK Z. (SLO)
32	DANISOVA Ema (SVK)	32	DANISOVA E. (SVK) 111 s0/ 000 s1 [01:27]

REPECHAGE

12	SHATTOCK M. (GBR)	12	RUCHTI N. (SUI) 000 s0/ 101 s0 [02:52]
12	BAUER S. (AUT)	13	BAUER S. (AUT) 100 s0/ 002 s0 [01:42]
12	LAWLOR V. (GBR)	13	TRAHAVIK A. (NOR) 100 s0/ 000 s0 [00:46]
12	GESA D. (CAN)	13	LOZOVIUK D. (UKR) 000 s0/ 002 s1 [04:00]
		13	BOLTVANOVA L. (SVK) 100 s0/ 000 s0 [01:07]

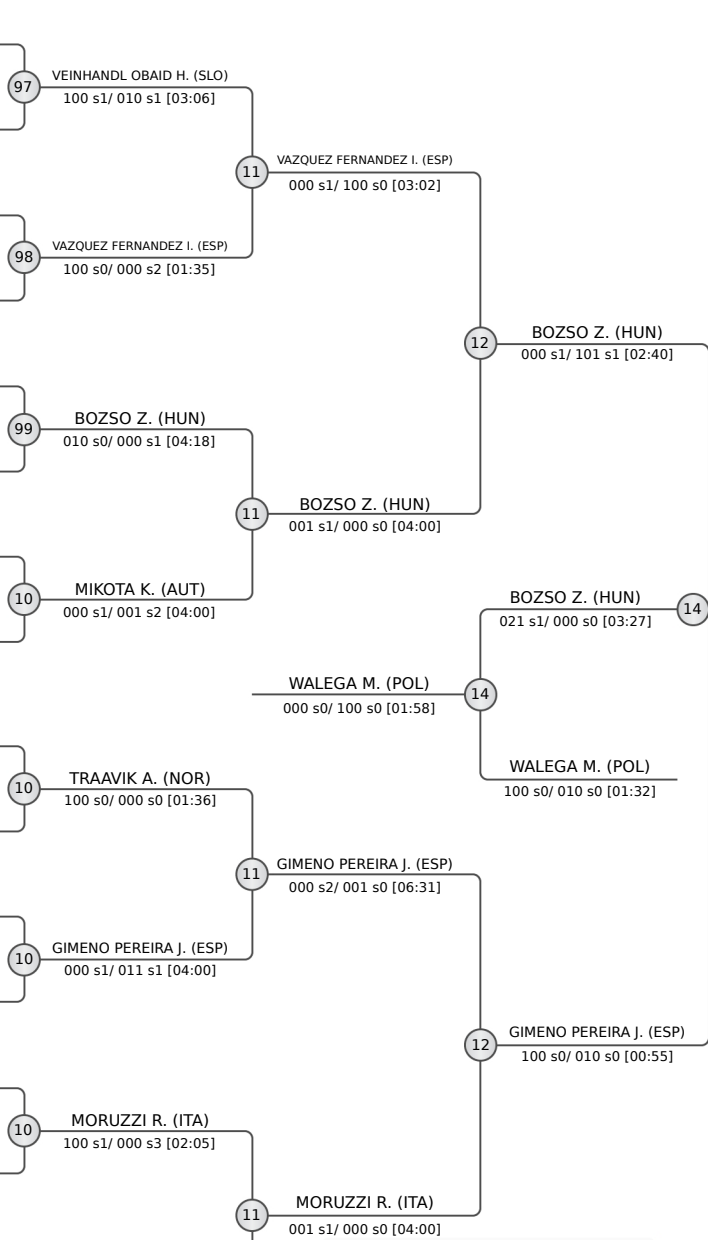

FINAL RESULTS	
1.	WALEGA Magdalena (POL)
2.	BOZSO Zita (HUN)
3.	MORUZZI Rachele (ITA)
3.	GIMENO PEREIRA Julia (ESP)
5.	PAVEN Amelia (ROU)
5.	ZIJADE Enise (KOS)
7.	RUCHTI Noemi (SUI)
7.	LOZOVIUK Daria (UKR)



Porec Millennium Team Cadet European Cup 2025

Croatia, Porec, 15-16 Mar 2025

-57 kg

Cadets (66)

POOL C

	WALEGA Magdalena	POL	33	WALEGA M. (POL)	
	LAWLOR Valentina	GBR	34	LAWLOR V. (GBR)	81
	MOHAROS Zsafia	HUN	35	MOHAROS Z. (HUN)	
	ILIC Milica	SRB	36	ILIC M. (SRB)	82
	JASIKOVAC Nikolina	BIH	37	JASIKOVAC N. (BIH)	
	BALIC Lucija	CRO	38	BALIC L. (CRO)	83
	LOGONDER Tjasa	SLO	39	LOGONDER T. (SLO)	
	MAMMADTAGHIYEVA Gulnaz	AZE	40	MAMMADTAGHIYEVA G. (AZE)	84
	ZIJADE Enise	KOS	41	ZIJADE E. (KOS)	
	STAIU Patricia	ROU	42	STAIU P. (ROU)	85
	ILIEVA Boyana	BUL	43	ILIEVA B. (BUL)	
	CINKOPAN Ilenia	CRO	44	CINKOPAN I. (CRO)	86
	BERTELLI Matilde	ITA	45	BERTELLI M. (ITA)	
	HALLER Eva	AUT	46	HALLER E. (AUT)	87
	KASIRER Talia	ISR	47	UHLMANN C. (SUI)	
	UHLMANN Chiara	SUI	48	UHL MANN C. (SUI)	000 s0/ 020 s0 [00:41]
	VATER Fiona	GER		VATER F. (GER)	88
				VATER F. (GER)	000 s0/ 001 s1 [04:00]

POOL D

	PAVEN Amelia	ROU	49	PAVEN A. (ROU)	
	GESA Dilana	CAN	50	GESA D. (CAN)	89
	ALONSO FERNANDEZ Sara	ESP	51	ALONSO FERNANDEZ S. (ESP)	
	LOZOVIUK Daria	UKR	52	LOZOVIUK D. (UKR)	90
	NOVAKOVIC Lana	SRB	53	NOVAKOVIC L. (SRB)	
	JURAS Nala	CRO	54	JURAS N. (CRO)	91
	BOLTVAANOVA Lea	SVK	55	BOLTVAANOVA L. (SVK)	
	DE BRINCAT Lily	AUS	56	DE BRINCAT L. (AUS)	92
	DUDKO Aleksandra	GBR	57	DUDKO A. (GBR)	
	SORSAK Ziva	SLO	58	SORSAK Z. (SLO)	93
	SEYR Julia	AUT	59	SEYR J. (AUT)	
	BANDI Synthia	HUN	60	BANDI S. (HUN)	94
	YUSIFLI Samaya	AZE	61	YUSIFLI S. (AZE)	
	ZEDDA Lucrezia	ITA	62	ZEDDA L. (ITA)	95
	CVETKOVIC Jana	SRB	63	CVETKOVIC J. (SRB)	
	PREVENDAR Paola	CRO	64	PREVENDAR P. (CRO)	96

REPECHAGE

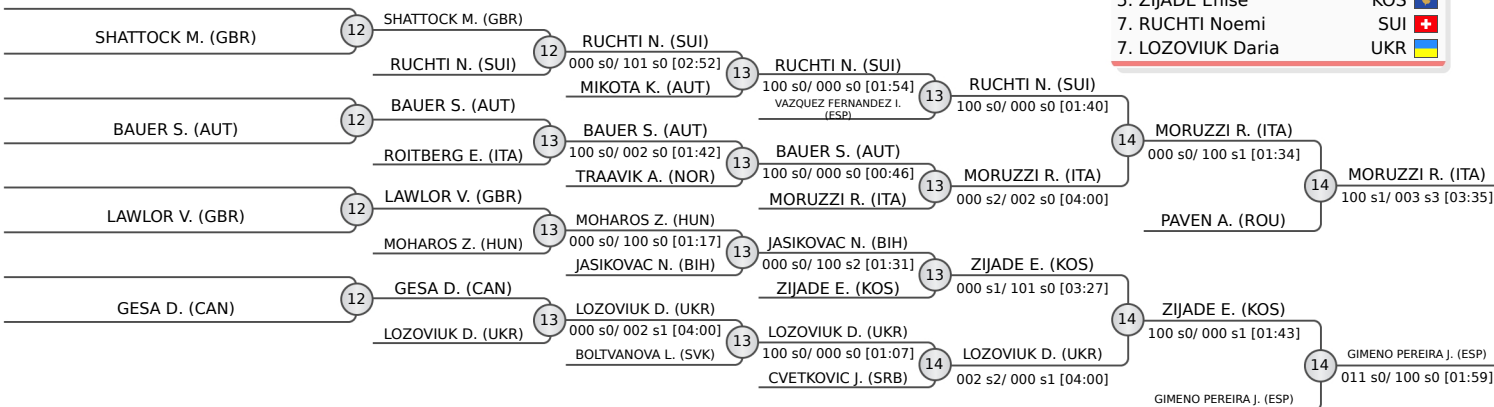

FINAL RESULTS		
1.	WALEGA Magdalena	POL
2.	BOZSO Zita	HUN
3.	MORUZZI Rachele	ITA
3.	GIMENO PEREIRA Julia	ESP
5.	PAVEN Amelia	ROU
7.	ZIJADE Enise	KOS
7.	RUCHTI Noemi	SUI
7.	LOZOVIUK Daria	UKR



Porec Millennium Team Cadet European Cup 2025

Croatia, Porec, 15-16 Mar 2025

-63 kg

Cadets (47)

POOL A

1	TSURKAN Ilariia (UKR)	1	TSURKAN I. (UKR)
2	STAROVASNIK Timeja (SLO)	2	STORM S. (GER)
3	STORM Sophia Grace (GER)	3	PRELCEC T. (CRO)
4	PRELCEC Tena (CRO)	4	IASEVOLI E. (ITA)
5	STEVOVIC Teodora (MNE)	5	SKILJEVIC A. (BIH)
6	IASEVOLI Emma (ITA)	6	ESCASO HURTADO V. (ESP)
7	SKILJEVIC Ana (BIH)	7	PINTER J. (HUN)
8	BARRIER MONTAGNON Lysandre (FRA)	8	POPOVIC K. (CRO)
	ESCASO HURTADO Visitacion (ESP)		
	PINTER Julia (HUN)		
	SEMETE Karina (GBR)		
	POPOVIC Kaja (CRO)		

POOL B

9	FROSONI Giorgia (ITA)	9	FROSONI G. (ITA)
10	JEAN Chloe (FRA)	10	JEAN C. (FRA)
11	KOMODOWSKI Ingrid (DEN)	11	SCHWARZBAUER C. (AUT)
12	IVIC Marta (CRO)	12	BJARNADOTTIR H. (ISL)
13	SCHWARZBAUER Carina (AUT)	13	THOMSON M. (CAN)
14	BJARNADOTTIR Helena (ISL)	14	ROEMMER A. (GER)
15	THOMSON Maia (CAN)	15	GLIGA A. (ROU)
16	SELAN Paulina (SLO)	16	DIVON M. (ISR)
	ROEMMER Amelie (GER)		
	SLEZAK Greta (CRO)		
	GLIGA Ana (ROU)		
	DIVON Maya (ISR)		

POOL C

17	WOZNICZKO Nadia (POL)	17	WOZNICZKO N. (POL)
18	SCARSO Chiara (ITA)	18	SIMANIC A. (BIH)
19	SIMANIC Ana (BIH)	19	TOROK C. (HUN)
20	AMICHAY Alma (ISR)	20	MAIDANA J. (ARG)
21	TOROK Csenge (HUN)	21	PAVLOVIC N. (SRB)
22	MAIDANA Juana (ARG)	22	BACHLER A. (AUT)
23	PAVLOVIC Nevena (SRB)	23	KALACANOVIC Andrea (CRO)
24	BACHLER Anna (AUT)	24	SAMOILIU D. (UKR)
	KALACANOVIC Andrea (CRO)		
	SAMOILIU D. (UKR)		
	KOPITAR Lana (SLO)		
	BOZKURT Narin (GER)		

POOL D

25	DALMASSO Madeleine (FRA)	25	DALMASSO M. (FRA)
26	RAMA Bleona (AUT)	26	ADAMACHI M. (ROU)
27	ADAMACHI Maya (ROU)	27	STOCK L. (GER)
28	IMERI Esra (CRO)	28	PIGAT E. (ITA)
29	STOCK Luisa (GER)	29	ANDRICH N. (SRB)
30	PIGAT Elisa (ITA)	30	RUSU M. (MDA)
31	ANDRICH Nina (SRB)	31	MATUSZEKOVA P. (SVK)
32	BAGO Ana (CRO)	32	MCGILL B. (GBR)
	RUSU Maria (MDA)		
	MATUSZEKOVA Paula (SVK)		
	MCGILL Bronach Mary (GBR)		

REPECHAGE

61	STORM S. (GER)	61	STORM S. (GER)
62	JEAN C. (FRA)	62	JEAN C. (FRA)
63	SIMANIC A. (BIH)	63	SIMANIC A. (BIH)
64	ADAMACHI M. (ROU)	64	ADAMACHI M. (ROU)
65	IASEVOLI E. (ITA)	65	IASEVOLI E. (ITA)
66	SCHWARZBAUER C. (AUT)	66	SCHWARZBAUER C. (AUT)
67	TOROK C. (HUN)	67	TOROK C. (HUN)
68	STOCK L. (GER)	68	STOCK L. (GER)
69	PINTER J. (HUN)	69	PINTER J. (HUN)
70	ROEMMER A. (GER)	70	ROEMMER A. (GER)
71	PAVLOVIC N. (SRB)	71	PAVLOVIC N. (SRB)
72	ANDRICH N. (SRB)	72	ANDRICH N. (SRB)

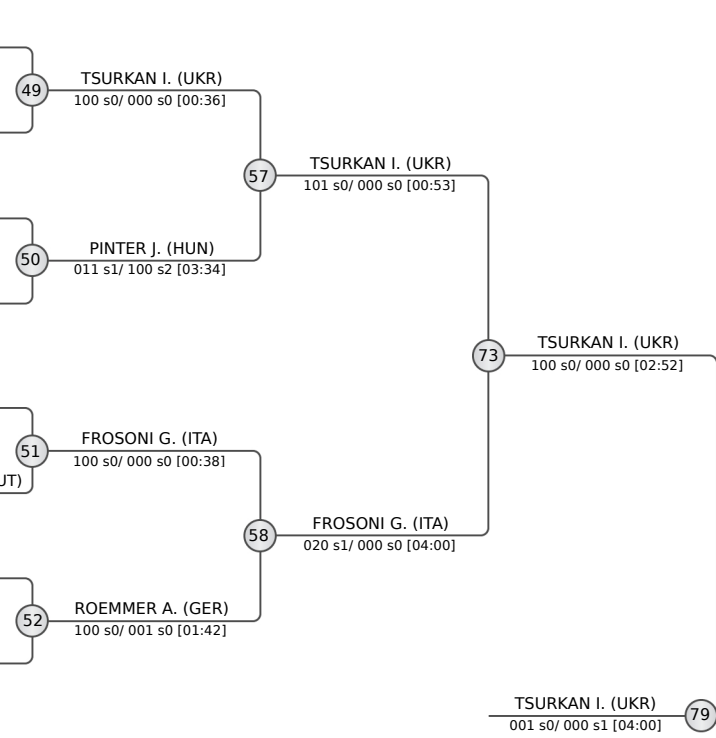

FINAL RESULTS		
1.	TSURKAN Ilariia	UKR
2.	WOZNICZKO Nadia	POL
3.	DALMASSO Madeleine	FRA
3.	FROSONI Giorgia	ITA
5.	JEAN Chloe	FRA
5.	ANDRICH Nina	SRB
7.	PINTER Julia	HUN
7.	SIMANIC Ana	BIH



Porec Millennium Team Cadet European Cup 2025

Croatia, Porec, 15-16 Mar 2025

-70 kg

Cadets (36)

POOL A

1	MCHENRY Hannah (AUS)	33	FEHER Z. (ROU)
2	FEHER Zara (ROU)	100 s1/ 000 s1 [03:10]	000 s3/ 100 s2 [05:11]
3	ZELL Amit (ISR)	GRASSI G. (ITA)	GRASSI G. (ITA)
4	GRASSI Giorgia (ITA)	34	GRASSI G. (ITA)
5	SPO LJAR Kaira Matijana (CRO)	35	ILIC S. (SRB)
6	SPO LJAR K. (CRO)	100 s0/ 000 s0 [00:45]	100 s0/ 000 s0 [00:45]
7	ILIC Sara (SRB)	36	FILZWIESER E. (AUT)
8	GLAVINA Nika (CRO)	50	FILZWIESER E. (AUT)
9	GLAVINA N. (CRO)	100 s0/ 000 s0 [04:00]	001 s2/ 000 s1 [04:00]
10	FILZWIESER Emma (AUT)	51	FILZWIESER E. (AUT)
11	FILZWIESER E. (AUT)	100 s0/ 000 s2 [02:17]	001 s0/ 110 s2 [04:00]
12	BENBRAHIM Amelia (FRA)	52	FILZWIESER E. (AUT)
13	BENBRAHIM A. (FRA)	100 s0/ 000 s0 [00:39]	001 s0/ 110 s2 [04:00]

POOL B

9	BESKER Ana (CRO)	37	BESKER A. (CRO)
10	MARCHIO' Claudia (ITA)	38	SANCHEZ VALLE A. (ESP)
11	SANCHEZ VALLE Andrea (ESP)	39	THIBAUT C. (CAN)
12	BAYRAMLI Malak (AZE)	40	RABL M. (AUT)
13	DOGSA Lara (SLO)	41	ZYS R. (POL)
14	THIBAUT Charlie (CAN)	42	JALILLI F. (AZE)
15	THIBAUT C. (CAN)	43	HUDIKA V. (CRO)
16	TERLETSKA Anna (UKR)	44	BAUMANN R. (AUT)
17	TERLETSKA A. (UKR)	45	VIGNA P. (ITA)
18	RABL Mavie (AUT)	46	HLADNIK N. (SLO)
19	JELCIC Ani (CRO)	47	BOB I. (ROU)
20	JELCIC A. (CRO)	48	PUPKO A. (ISR)

POOL C

17	ZYS Roksana (POL)	41	ZYS R. (POL)
18	ZAGO Kiara (CRO)	42	JALILLI F. (AZE)
19	PAVIC Natasa (AUT)	43	HUDIKA V. (CRO)
20	JALILLI Fidan (AZE)	44	LEFRANCOIS K. (FRA)
21	VLAHOVIC Teodora (MNE)	45	VIGNA P. (ITA)
22	VLAHOVIC T. (MNE)	46	HLADNIK N. (SLO)
23	HUDIKA Vita (CRO)	47	BOB I. (ROU)
24	HUDIKA V. (CRO)	48	PUPKO A. (ISR)
25	DOVHUN Yana (UKR)	49	GRASSI G. (ITA)
26	DOVHUN Y. (UKR)	50	FILZWIESER E. (AUT)
27	LEFRANCOIS Kiara (FRA)	51	BESKER A. (CRO)
28	LEFRANCOIS K. (FRA)	52	THIBAUT C. (CAN)
29	BAUMANN Rosalie (AUT)	53	ZYS R. (POL)
30	BAUMANN R. (AUT)	54	HUDIKA V. (CRO)

POOL D

25	BENKOVA Diana (POL)	45	VIGNA P. (ITA)
26	MISIC Antonia (CRO)	46	HLADNIK N. (SLO)
27	VIGNA Petra (ITA)	47	BOB I. (ROU)
28	HLADNIK Neza (SLO)	48	PUPKO A. (ISR)
29	HLADNIK N. (SLO)	49	GRASSI G. (ITA)
30	DUMINICA Madina (MDA)	50	FILZWIESER E. (AUT)
31	DUMINICA M. (MDA)	51	BESKER A. (CRO)
32	WOEGERER Selina (AUT)	52	THIBAUT C. (CAN)
33	WOEGERER S. (AUT)	53	ZYS R. (POL)
34	BOB Isabel (ROU)	54	HUDIKA V. (CRO)
35	BOB I. (ROU)	55	Hladnik N. (SLO)
36	PUPKO Arielle (ISR)	56	Bob I. (ROU)
37	PUPKO A. (ISR)	57	Feher Z. (ROU)
38	BRALIC Sara (CRO)	58	Besker A. (CRO)
39	BRALIC S. (CRO)	59	ZYS R. (POL)

REPECHAGE

61	SPO LJAR K. (CRO)	65	FEHER Z. (ROU)
62	MARCHIO' C. (ITA)	66	SANCHEZ VALLE A. (ESP)
63	PAVIC N. (AUT)	67	JALILLI F. (AZE)
64	DUMINICA M. (MDA)	68	BENKOVA D. (POL)
65	FEHER Z. (ROU)	69	FEHER Z. (ROU)
66	MARCHIO' C. (ITA)	70	SANCHEZ VALLE A. (ESP)
67	PAVIC N. (AUT)	71	HUDIKA V. (CRO)
68	DUMINICA M. (MDA)	72	BOB I. (ROU)
69	FEHER Z. (ROU)	73	GRASSI G. (ITA)
70	SANCHEZ VALLE A. (ESP)	74	ZYS R. (POL)
71	HUDIKA V. (CRO)	75	FEHER Z. (ROU)
72	BOB I. (ROU)	76	BOB I. (ROU)
73	GRASSI G. (ITA)	77	HLADNIK N. (SLO)
74	ZYS R. (POL)	78	BESKER A. (CRO)
75	FEHER Z. (ROU)		
76	BOB I. (ROU)		
77	HLADNIK N. (SLO)		
78	BESKER A. (CRO)		

FINAL RESULTS		
1.	ZYS Roksana	POL
2.	GRASSI Giorgia	ITA
3.	HLADNIK Neza	SLO
3.	BESKER Ana	CRO
5.	FEHER Zara	ROU
5.	BOB Isabel	ROU
7.	SANCHEZ VALLE Andrea	ESP
7.	HUDIKA Vita	CRO



Porec Millennium Team Cadet European Cup 2025

Croatia, Porec, 15-16 Mar 2025

+ 70 kg

Cadets (20)

POOL A

	TROKA Julia	POL
	MAGASSA FOFANA Sogona	ESP
	PALERMO Elisa	ITA
	NIKETIC Leona	CRO
	SAMOLIUK Anna	UKR

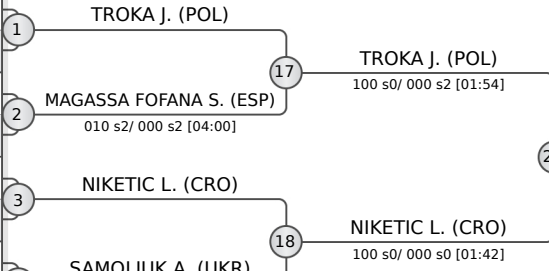

POOL B

	RADAKOVIC Milica	SRB
	SKRABAN Lana	SLO
	MILANOVIC Lucija	CRO
	HOELLWART Michaela	AUT
	BORRHOMEE Maelle	FRA

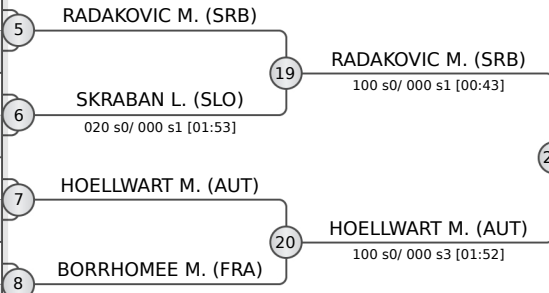

POOL C

	ZAREBA Nikola	POL
	DJEDIAT Imen	SUI
	COULIBALY TOURE Ballalo	ESP
	SACKO Astan	FRA
	ZENUNI Sara	ITA

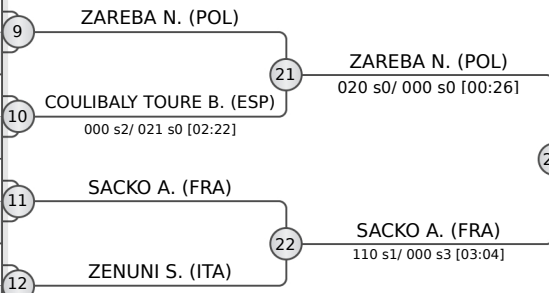

POOL D

	SCHIAVON Carlotta	ITA
	JURAK Jazmin	HUN
	AJDUKOVIC Antea	CRO
	MRAKOVIC Una	SRB
	BAHMET Kira	UKR

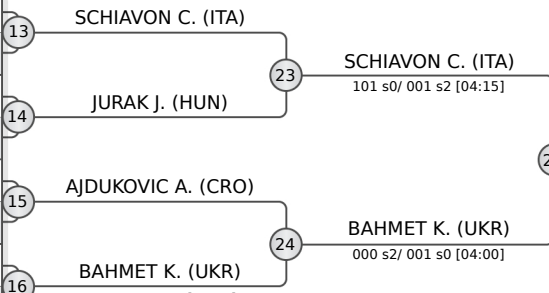

REPECHAGE

MAGASSA FOFANA S. (ESP) 29	MAGASSA FOFANA S. (ESP) 33
BORRHOMEE M. (FRA) 30	RADAKOVIC M. (SRB) 34
ZENUNI S. (ITA) 31	ZAREBA N. (POL) 35
MRAKOVIC U. (SRB) 32	AJDUKOVIC A. (CRO) 36
AJDUKOVIC A. (CRO) 32	SCHIAVON C. (ITA) 36

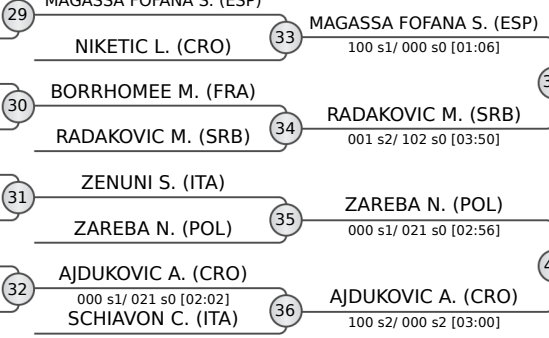

FINAL RESULTS

- TROKA Julia
- SACKO Astan
- RADAKOVIC Milica
- AJDUKOVIC Antea
- BAHMET Kira
- HOELLWART Michaela
- MAGASSA FOFANA Sogona
- ZAREBA Nikola